



MAHARASHTRA NATURAL GAS LTD

(A joint venture of GAIL(India) Ltd & BPCL)

CNG & CITY GAS DISTRIBUTION PROJECT
FOR PUNE

**BID DOCUMENT
FOR**

**Bi-Annual Rate Contract for procurement of stickers & Nozzle
Holder for CNG Dispenser for MNGL, Pune.**

UNDER LIMITED DOMESTIC COMPETITIVE BIDDING

Bid Doc. No.: MNGL/C&P/2018-19/45



**MAHARASHTRA NATURAL
GAS LIMITED**

**Tender for Bi-Annual Rate Contract for procurement of
stickers & Nozzle Holder for CNG Dispenser for MNGL,
Pune.**

Bid No.: MNGL/C&P/2018-19/45

CONTENTS

- PART – A : INVITATION FOR BIDS**
- PART – B : INSTRUCTION TO BIDDERS
ANNEXURES TO INSTRUCTIONS TO BIDDERS**
- PART – C : GENERAL CONDITIONS OF CONTRACT**
- PART – D : SCOPE OF WORK & SPECIAL CONDITIONS OF
CONTRACT (SCC)**
- PART – E : SCHEDULE OF RATES (SOR)**



**MAHARASHTRA NATURAL
GAS LIMITED**

**Tender for Bi-Annual Rate Contract for procurement of
stickers & Nozzle Holder for CNG Dispenser for MNGL,
Pune.**

Bid No.: MNGL/C&P/2018-19/45

**PART A
INVITATION FOR BIDS (IFB)**

BID DOCUMENT NO.: MNGL/C&P/2018-19/45

Date: 21.07.2018

To,

.....
.....

Dear Sir,

M/s Maharashtra Natural Gas Ltd., Pune invites sealed bids **UNDER TWO BID SYSTEM** for the item(s) in complete accordance with the Bid Documents/ Attachments.

The salient terms and conditions of the bid are stated below:

- | | | |
|--|----------|---|
| I. PROJECT | : | City Gas Distribution Project for Pune |
| II. TYPE OF BID | : | Limited Domestic Competitive Bidding |
| III. ITEM(S) | : | Bi-Annual Rate Contract for procurement of stickers & Nozzle Holder for CNG Dispenser for MNGL, Pune. |
| IV. TIME SCHEDULE | : | As per Scope of Work & Note to SOR |
| V-A. EARNEST MONEY/
BIDSECURITY | : | Rs. 31,000/- in the form of Demand Draft / BG to be in favour of "Maharashtra Natural Gas Ltd." payable at Pune. |
| V-B. BID SECURITY VALIDITY | : | 6(SIX) months from bid due date |
| VI. DUE DATE OF SUBMISSION
OF BID | : | 04.08.2018 upto 15:00 hrs. |
| VIII. BID VALIDITY | : | 4(four) months from the bid due date |
| IX. TECHNO-COMMERCIAL BID
OPENING DUE DATE & TIME | : | 04.08.2018 at 16:00 hrs. |
| X. VENUE | : | Address & Contact Nos. given at Sl. No. XIII. |
| XI. TENDER FEE | : | Not Applicable |
| XII. BID EVALUATION
CRITERIA | : | For Complete scope of work |



**MAHARASHTRA NATURAL
GAS LIMITED**

**Tender for Bi-Annual Rate Contract for procurement of
stickers & Nozzle Holder for CNG Dispenser for MNGL,
Pune.**

Bid No.: MNGL/C&P/2018-19/45

XIII. ADDRESS FOR CORRESPONDENCE & SUBMISSION OF BID DOCUMENT : Shekhar D. Kankrej, Dy. Manager (C&P)
Maharashtra Natural Gas Ltd.
Plot No. 27, 1st Floor,
Narveer Tanajiwadi PMPML Bus Depot
Commercial Building, Shivajinagar,
Pune – 411005
Ph. No. 91-20-25611000
Fax No. 91-20-25511522

XIV. BIDDER ELIGIBILITY CRITERIA : Annexure – I to IFB

XV. OTHERS:

The bidder can download the Bidding Document from MNGL web-site and the downloaded bid document is to be submitted with an undertaking that the contents of the Bidding Document have not been altered or modified.

In case you download the tender document and interested to quote, please intimate to us showing your interest immediately along-with complete contact address, phone no., fax no., e-mail etc. for correspondence. Owner will inform about Addendum, if any to those who have furnished above information. However, information about Addendum shall also be available on MNGL's websites as and when these are issued.

The complete Bidding Document is also available on the web site of MNGL (www.mngl.in)

- 1.0 Bid Document is non-transferable.
- 2.0 Bids complete in all respects should reach on or before the BID DUE DATE AND TIME. Bids through Fax/ E-mail shall not be considered.

Applicable in case of Open Competitive bidding - Bidder may depute their representative with proper authorization letter to attend of techno-commercial opening of bids.

- 3.0 The Bid Document calls for offers on single point "Sole Bidder" responsibility basis.

Order will be placed on the "Sole Bidder" alone (in whose name the bid document has been issued) who will be responsible for all contractual purposes.

Further the bidders are advised to ensure that their offer is on single bidder responsibility basis and in total compliance of scope of supply as specified in Bid Document.

- 4.0 The bid should be prepared by the "Sole Bidder" and should be sent to MNGL directly. MNGL reserve the right to reject offers made by intermediaries' representatives.

- 5.0 Bidder shall ensure that Bid Security having a validity of 6(SIX) months from the bid due date, must accompany the offer in the format made available in the Bid Document.

- 6.0 This Invitation for Bids (IFB) is an integral and inseparable part of the enclosed Bid Document.



**MAHARASHTRA NATURAL
GAS LIMITED**

**Tender for Bi-Annual Rate Contract for procurement of
stickers & Nozzle Holder for CNG Dispenser for MNGL,
Pune.**

Bid No.: MNGL/C&P/2018-19/45

7.0 MNGL reserves the right to accept or reject any or all offers without assigning any reason, whatsoever.

8.0 ZERO DEVIATION TENDER

Bidder shall note that if any deviations are taken to the under mentioned provisions of Bid Documents by the Bidder the bid is liable to be rejected:-

- i) Do not meet BEC Criteria
- ii) Bid Security
- iii) Performance Security (Contract Performance Bank Guarantee), 10% of Annualized Contract / Order value
- iv) Delivery Period
- v) Terms of Payment
- vi) Force Majeure
- vii) Resolution of Dispute/Arbitration
- viii) Termination of Contract,
- ix) Warranty and Guarantee
- x) Offer not submitted for complete scope of work
- xi) Firm prices
- xii) Prices not quoted as per Schedule of Rates formats.
- xiii) Bidder have been banned by Government of India or any its Agency/ Undertaking/ Department of Government of India.
- xiv) Bidder is under liquidation.
- xv) Bidder is under litigation which owner's considers a disqualification.
- xvi) Bids not conforming to technical specification/requirements.
- xvii) Any other such provisions if specifically stipulated elsewhere in the Bid Document.
- xviii) Price Reduction Schedule.

However, MNGL reserve the right to request the bidder to withdraw the deviations against above-mentioned provisions of Bid Documents.

9.0 SEALING & MARKING OF BIDS

Bids should be submitted in complete accordance with the bid documents / attachments separately in three parts in sealed envelopes super-scribed with the Bid Document Number, due date, item and nature of bid (un-priced, priced), as follows :

Part-I : UNPRICED BID
Part-II : PRICE BID
Part-III : Bid Security

The three envelopes, containing Part-I, Part-II & Part-III of offer, shall be duly sealed and respective cutout slip enclosed with this letter as Appendix-A shall be pasted on each envelop. Name & address of the bidder shall be mentioned on each cut-out slip. These three sealed envelopes shall be further kept in a larger envelope & which shall also be duly sealed. Cut-out slip meant for complete offer shall be pasted on it with name and complete address & contact number of the bidder.

THIS IS NOT AN ORDER

Yours faithfully,



**MAHARASHTRA NATURAL
GAS LIMITED**

**Tender for Bi-Annual Rate Contract for procurement of
stickers & Nozzle Holder for CNG Dispenser for MNGL,
Pune.**

Bid No.: MNGL/C&P/2018-19/45

for Maharashtra Natural Gas Limited, Pune

(Shekhar D. Kankrej)
Dy. Manager (C&P)

- Encl. 1. Appendix – A - 4(four) nos. of Cut-Out slips to be pasted on different sealed envelopes of the offer.
2. Bid Document.

Note:

Please confirm your intention to quote or not within 7(Seven) days. In case not intending to quote then please give your valuable feedback to us.

 MAHARASHTRA NATURAL GAS LIMITED	<u>Tender for Bi-Annual Rate Contract for procurement of stickers & Nozzle Holder for CNG Dispenser for MNGL, Pune.</u> Bid No.: MNGL/C&P/2018-19/45
---	---

ANNEXURE-I to IFB

BIDDER'S ELIGIBILITY CRITERIA

1. **Name of Work:**
"Bi annual rate contract for procurement of stickers & nozzle holder for CNG Dispensers for MNGL, Pune"
2. **Contract period :**
The period of contract shall be 2 years from the date service order, further extendable for another 1 (one) year on the same terms & conditions.
3. **Bidding Philosophy:**
The bidders shall have to quote for the complete SOR as given in the tender.
4. **Evaluation and award of work:**

Evaluation shall be done as per complete SOR (i.e. on total evaluated price)

5.0 **BEC – Technical**

- 5.1 The Bidder should have executed a similar type of work of order value not less than Rs. 3.80 Lacs in a single order OR two work orders of order value not less than Rs. 1,90,000 each, in last five years reckoned from the bid due date.

To meet the above criteria, bidder must submit documentary evidences viz. detailed Work Order copies, completion certificate / performance certificate from Client and any other relevant documents in support of his claim. In absence of requisite documents, MNGL reserves the right to reject the bid without making any reference to the bidder.

In absence of requisite documents, MNGL reserves the right to reject the bid without making any reference to the bidder.

6.0 **BEC – Financial**

6.1 **Turnover**

The bidder should have achieved a minimum turnover of Rs. 3.80 Lacs in any one of the last 3 (three) financial years i.e.2015-16, 2016-17 & 2017-18.

6.2 **Working Capital**

The bidder should have a minimum working capital of Rs. 76,000 /- as per latest balance sheet i.e. for the year 2017-18. If the bidder's working capital is inadequate, the bidder should supplement this with a letter from bidder's bank having net worth not less than Rs. 100.00 Crores, confirming the availability of line of credit to cover the inadequacy of previous year i.e. 2016-17 and meet the current working capital requirement.



**MAHARASHTRA NATURAL
GAS LIMITED**

**Tender for Bi-Annual Rate Contract for procurement of
stickers & Nozzle Holder for CNG Dispenser for MNGL,
Pune.**

Bid No.: MNGL/C&P/2018-19/45

2.3 Net Worth

Net worth must be positive as per last financial statement i.e. for the financial year 2017-18.

Bidders must submit documentary evidence such as Balance Sheet and Profit & Loss Account Statement certified by Chartered Accountant / Certified Auditors for last three financial years in support of the above.

If the audited financial results of the immediate preceding financial year i.e. 2017-18 is not available, then the audited financial results of the year immediately prior to 2017-18 i.e. 2016-17 shall be considered for calculation of Annual Turnover, Net Worth and Working Capital as specified at Cl. 6.0 of Financial Criteria.

In absence of requisite documents, MNGL reserve the right to reject the bid without making any reference to the bidder.”



**MAHARASHTRA NATURAL
GAS LIMITED**

**Tender for Bi-Annual Rate Contract for procurement of
stickers & Nozzle Holder for CNG Dispenser for MNGL,
Pune.**

Bid No.: MNGL/C&P/2018-19/45

APPENDIX – A

CUT-OUT SLIPS (4 NOS.)

 MAHARASHTRA NATURAL GAS LIMITED	<u>Tender for Bi-Annual Rate Contract for procurement of stickers & Nozzle Holder for CNG Dispenser for MNGL, Pune.</u> Bid No.: MNGL/C&P/2018-19/45
---	---

CUT-OUT SLIP – 1

(OUTER ENVELOPE)

DO NOT OPEN-THIS IS A QUOTATION

PROJECT : City Gas Distribution Project for Pune

BID DOCUMENT NO : MNGL/C&P/2018-19/45

**ITEM : Tender for Bi-Annual Rate Contract for procurement of
stickers & Nozzle Holder for CNG Dispenser for MNGL,
Pune.**

DUE DATE OF SUBMISSION & TIME : 04.08.2018 upto 15:00 Hrs.

TO,

**Dy. Manager (C&P)
Maharashtra Natural Gas Ltd.
Plot No. 27, 1st Floor, Narveer Tanajiwadi
PMPML Bus Depot Commercial Building,
Shivajinagar,
Pune - 411005
Ph. No. 020-25611000
Fax No. 020-25511522**

FROM

NAME:

ADDRESS

PHONE NO.

FAX NO.

(To be pasted on the outer envelope containing "Priced bid", "Unpriced bid" and "Bid security/ EMD")



**MAHARASHTRA NATURAL
GAS LIMITED**

**Tender for Bi-Annual Rate Contract for procurement of
stickers & Nozzle Holder for CNG Dispenser for MNGL,
Pune.**

Bid No.: MNGL/C&P/2018-19/45

CUT-OUT SLIP – 2

PART – I (UNPRICED BID)

DO NOT OPEN-THIS IS A QUOTATION

PROJECT : City Gas Distribution Project for Pune

BID DOCUMENT NO : MNGL/C&P/2018-19/45

**ITEM : Tender for Bi-Annual Rate Contract for procurement of
stickers & Nozzle Holder for CNG Dispenser for MNGL,
Pune.**

**DUE DATE OF : 04.08.2018 upto 15:00 Hrs.
SUBMISSION & TIME**

TO,

**Dy. Manager (C&P)
Maharashtra Natural Gas Ltd.
Plot No. 27, 1st Floor, Narveer Tanajiwadi
PMPML Bus Depot Commercial Building,
Shivajinagar,
Pune - 411005
Ph. No. 020-25611000
Fax No. 020-25511522**

FROM

NAME:

ADDRESS

PHONE NO.

FAX NO.

(To be pasted on the envelope containing "Unpriced" bid)



**MAHARASHTRA NATURAL
GAS LIMITED**

**Tender for Bi-Annual Rate Contract for procurement of
stickers & Nozzle Holder for CNG Dispenser for MNGL,
Pune.**

Bid No.: MNGL/C&P/2018-19/45

CUT-OUT SLIP – 3

PART – II (PRICED BID)

DO NOT OPEN-THIS IS A QUOTATION

PROJECT : City Gas Distribution Project for Pune

BID DOCUMENT NO : MNGL/C&P/2018-19/45

**ITEM : Tender for Bi-Annual Rate Contract for procurement of
stickers & Nozzle Holder for CNG Dispenser for MNGL,
Pune.**

**DUE DATE OF : 04.08.2018 upto 15:00 Hrs.
SUBMISSION & TIME**

TO,

**Dy. Manager (C&P)
Maharashtra Natural Gas Ltd.
Plot No. 27, 1st Floor, Narveer Tanajiwadi
PMPML Bus Depot Commercial Building,
Shivajinagar,
Pune - 411005
Ph. No. 020-25611000
Fax No. 020-25511522**

FROM

NAME:

ADDRESS

PHONE NO.

FAX NO.

(To be pasted on the envelope containing "Priced" bid)

 MAHARASHTRA NATURAL GAS LIMITED	<u>Tender for Bi-Annual Rate Contract for procurement of stickers & Nozzle Holder for CNG Dispenser for MNGL, Pune.</u> Bid No.: MNGL/C&P/2018-19/45
---	---

CUT-OUT SLIP – 4

PART – III (Bid Security / EMD)

DO NOT OPEN-THIS IS A QUOTATION

PROJECT : City Gas Distribution Project for Pune

BID DOCUMENT NO : MNGL/C&P/2018-19/45

**ITEM : Tender for Bi-Annual Rate Contract for procurement of
stickers & Nozzle Holder for CNG Dispenser for MNGL,
Pune.**

DUE DATE OF SUBMISSION & TIME : 04.08.2018 upto 15:00 Hrs.

TO,

**Dy. Manager (C&P)
Maharashtra Natural Gas Ltd.
Plot No. 27, 1st Floor, Narveer Tanajiwadi
PMPML Bus Depot Commercial Building,
Shivajinagar,
Pune - 411005
Ph. No. 020-25611000
Fax No. 020-25511522**

FROM

NAME:

ADDRESS

PHONE NO.

FAX NO.

(To be pasted on the envelope containing “Bid Security / EMD”)



**MAHARASHTRA NATURAL
GAS LIMITED**

**Tender for Bi-Annual Rate Contract for procurement of
stickers & Nozzle Holder for CNG Dispenser for MNGL,
Pune.**

Bid No.: MNGL/C&P/2018-19/45

2.0 ACKNOWLEDGEMENT CUM CONSENT LETTER



**MAHARASHTRA NATURAL
GAS LIMITED**

**Tender for Bi-Annual Rate Contract for procurement of
stickers & Nozzle Holder for CNG Dispenser for MNGL,
Pune.**

Bid No.: MNGL/C&P/2018-19/45

ACKNOWLEDGEMENT CUM CONSENT LETTER

To,
M/s Maharashtra Natural Gas Limited
Plot No. 27, 1st Floor,
Narveer Tanajiwadi PMPML Bus Depot Commercial Building,
Shivajinagar,
Pune – 411005
Ph.No.: 91-20-25611000
Fax No.: 91-20-25511522
E-mail : skankrej@mngl.in

Kind Attn: Shri Shekhar D Kankrej, Dy. Manager (C&P)

Sub:

Dear Sir,

We hereby acknowledge receipt of complete set of Bid Document along with enclosures for the subject works. We understand that documents received remain property of M/s. Maharashtra Natural Gas Limited and further undertake that the contents of the above bid documents shall be kept confidential and shall not be transferred. We indicate below our intentions with respect to the Invitation for Bid.

a) We intend to bid as requested and furnish following details with respect to our quoting office:-

- I) POSTAL ADDRESS : _____

- II) TELEPHONE NO. : _____
- III) TELEFAX NO. : _____
- IV) E-MAIL : _____
- V) CONTACT PERSON : _____

b) Contact Person at Pune, if any:-

- I) POSTAL ADDRESS : _____

- II) TELEPHONE NO. : _____



**MAHARASHTRA NATURAL
GAS LIMITED**

**Tender for Bi-Annual Rate Contract for procurement of
stickers & Nozzle Holder for CNG Dispenser for MNGL,
Pune.**

Bid No.: MNGL/C&P/2018-19/45

- III) TELEFAX NO. : _____
- IV) E-MAIL : _____
- V) CONTACT PERSON : _____

- c) We are hereby returning the bid document as we are unable to bid for the reasons given below.

Reasons for non-submission of Bid:

COMPANY'S NAME : _____

SIGNATURE : _____

NAME : _____

DESIGNATION : _____

DATE : _____

Note: Bidder is requested to furnish the details mentioned at (a), (b) & (c) above as applicable, immediately after receipt of Bid Document.

(SIGNATURE OF BIDDER)



**MAHARASHTRA NATURAL
GAS LIMITED**

**Tender for Bi-Annual Rate Contract for procurement of
stickers & Nozzle Holder for CNG Dispenser for MNGL,
Pune.**

Bid No.: MNGL/C&P/2018-19/45

3.0 SUBMISSION OF BID



**MAHARASHTRA NATURAL
GAS LIMITED**

**Tender for Bi-Annual Rate Contract for procurement of
stickers & Nozzle Holder for CNG Dispenser for MNGL,
Pune.**

Bid No.: MNGL/C&P/2018-19/45

SUBMISSION OF BID

From:

M/s

To:

M/s Maharashtra Natural Gas Limited

Plot No. 27, 1st Floor,

Narveer Tanajiwadi PMPML Bus Depot Commercial Building,

Shivajinagar,

Pune – 411005

1. I/We hereby tender for execution of the WORKS of **Bi-Annual Rate Contract for procurement of stickers & Nozzle Holder for CNG Dispenser for MNGL, Pune** as per TENDER DOCUMENT within the Time Schedule of completion of work for jobs, as separately signed and accepted by me/us, at the Schedule of Rates quoted by me/us for the whole work in accordance with Notice/Letter Inviting Tender, General Conditions of Contract, Special Conditions of Contract, Schedule of Rates of Completion of Job, and other documents and papers, all as detailed in the Tender documents.
2. It has been explained to me/us that the time stipulated for jobs and completion of WORKS in all respects and in different stages mentioned in the "Time Schedule" of completion of jobs and signed and accepted by me/us in the essence of the CONTRACT. I/We agree that in the case of failure on my/our part to strictly observe the Time of Completion mentioned for jobs or any of them and to the Final Completion of WORK in all respects according to the schedule set out in the said "Time Schedule" of completion of jobs. I/We shall pay compensation to the OWNER as per provisions and stipulations contained in General Conditions of Contract and I/We agree to recovery being made as specified therein. In exceptional circumstances, extension of time which shall always be in writing may, however, be granted by the Engineer-in-Charge at his entire discretion for some items of work, and I/We agree that such extension of time will not be counted for the extension of completion dates stipulated for job and for the Final Completion of WORK as stipulated in the said "Time Schedule" of completion of jobs.
3. I/We agree to pay the Earnest Money and Contract Performance Bank Guarantee (CPBG) and accept the terms and conditions laid down in the memorandum below in this respect.



**MAHARASHTRA NATURAL
GAS LIMITED**

**Tender for Bi-Annual Rate Contract for procurement of
stickers & Nozzle Holder for CNG Dispenser for MNGL,
Pune.**

Bid No.: MNGL/C&P/2018-19/45

MEMORANDUM

(a) General Description of Work _____

(b) Earnest Money Rs. _____
(Rupees) _____

The Earnest Money is payable in the manner set out in para 5 below.

The Earnest Money, if the tender is accepted, will be adjusted against the Contract Performance Bank Guarantee (CPBG), when Earnest Money is paid by demand draft only.

(c) Contract Performance Bank Guarantee (CPBG) 10% of the ANNUALIZED CONTRACT amount which will be paid in the manner set out in the General Conditions of Contract.

4. Should this tender be accepted, I/We hereby agree to abide by and fulfill all terms and conditions referred to above and in default thereof, to forfeit and pay to the OWNER or its successors or its authorized nominees such sums of money as are stipulated in conditions contained in General Tender Notice and other Tender Documents.

5. I/We hereby pay the Earnest Money of Rs. _____ (Rupees _____) in Bank Demand Draft/Bank Guarantee No. _____ issued by _____ (name and office of the State Bank of India or any Nationalized Bank) in favour of Maharashtra Natural Gas Limited, Pune.

6. If I/We fail to commence the work specified in the Memorandum in Para (3) above, or I/We to deposit the amount of Contract Performance Bank Guarantee (CPBG) specified in the Memorandum in (3) above, I/We agree that the said OWNER or its successors without prejudice to any other right or remedy be at liberty to forfeit the said Earnest Money in full, otherwise the said Earnest Money shall be retained by OWNER towards the Contract Performance Bank Guarantee (CPBG) specified in (3) above. The said OWNER shall also be at liberty to cancel the Notice of Acceptance of Tender if I/We fail to deposit the Contract Performance Bank Guarantee (CPBG) as aforesaid or to execute an Agreement or to start WORK as stipulated in the Tender Documents.



**MAHARASHTRA NATURAL
GAS LIMITED**

**Tender for Bi-Annual Rate Contract for procurement of
stickers & Nozzle Holder for CNG Dispenser for MNGL,
Pune.**

Bid No.: MNGL/C&P/2018-19/45

I/We enclose herewith evidence of my/our experiment of execution of works of similar nature and magnitude carried out by me/us in the prescribed proforma and also the Income- Tax Clearance Certificates.

Dated the _____ day of _____ 2018

Witness:

Name in Block Letters:

Address:

Yours faithfully,
Signature of Tenderer(s) with the
seal of the Firm.

Name and Designation of authorized person signing the
Tender on behalf of the Tenderer(s).



**MAHARASHTRA NATURAL
GAS LIMITED**

**Tender for Bi-Annual Rate Contract for procurement of
stickers & Nozzle Holder for CNG Dispenser for MNGL,
Pune.**

Bid No.: MNGL/C&P/2018-19/45

PART – B



**MAHARASHTRA NATURAL
GAS LIMITED**

**Tender for Bi-Annual Rate Contract for procurement of
stickers & Nozzle Holder for CNG Dispenser for MNGL,
Pune.**

Bid No.: MNGL/C&P/2018-19/45

1.0 INSTRUCTION TO BIDDERS (ITB)



**MAHARASHTRA NATURAL
GAS LIMITED**

**Tender for Bi-Annual Rate Contract for procurement of
stickers & Nozzle Holder for CNG Dispenser for MNGL,
Pune.**

Bid No.: MNGL/C&P/2018-19/45

TABLE OF CONTENTS

- A. General
 - 1. Scope of Bid
 - 2. Eligible Bidders
 - 3. Bid Evaluation Criteria
 - 4. Bids from Consortium
 - 5. One Bid per Bidder
 - 6. Cost of Bidding
 - 7. Site Visit
- B. Bidding Documents
 - 8. Content of Bidding Documents
 - 9. Clarification of Bidding Documents
 - 10. Amendment of Bidding Documents
- C. Preparation of Bids
 - 11. Language of Bid
 - 12. Documents Comprising the Bid
 - 13. Bid Prices
 - 14. Bid Currencies
 - 15. Bid Validity
 - 16. Bid Security
 - 17. Pre-Bid Meeting
 - 18. Format and Signing of Bid
 - 19. Zero Deviation
 - 20. Mode of Payment
 - 21. Agent/ Consultant/ Representative/ Retainer/ Associate
- D. Submission of Bids
 - 22. Sealing and Marking of Bids
 - 23. Deadline for Submission of Bids
 - 24. Late Bids
 - 25. Modification and Withdrawal of Bids
- E. Bid Opening and Evaluation
 - 26. Bid Opening
 - 27. Process to be Confidential
 - 28. Contacting the Employer
 - 29. Examination of bids and Determination of Responsiveness
 - 30. Correction of Errors
 - 31. Conversion to Single Currency for Comparison of Bids
 - 32. Evaluation and Comparison of Bids
 - 33. Preference for Domestic bidders
 - 34. Purchase Preference
 - 35. Compensation of Extended Stay – **Not Applicable**
- F. Award of Contract
 - 36. Award
 - 37. Employer's Right to accept any bid and to reject any or all Bids
 - 38. Notification of Award
 - 39. Signing of Agreement
 - 40. Contract Performance Security
 - 41. Corrupt or Fraudulent Practices



**MAHARASHTRA NATURAL
GAS LIMITED**

**Tender for Bi-Annual Rate Contract for procurement of
stickers & Nozzle Holder for CNG Dispenser for MNGL,
Pune.**

Bid No.: MNGL/C&P/2018-19/45

INSTRUCTIONS TO BIDDERS

A. GENERAL

1. Scope of Bid

- 1.1 The Employer, as defined in the General Conditions of Contract, hereinafter “the Employer”, wishes to receive bids for the Work as described in bidding document.
- 1.2 The successful bidder will be expected to complete the Works within the period stated in Special Conditions of Contract.
- 1.3 Throughout these bidding documents, the terms “bid” and “tender” and their derivatives (“bidder/ tenderer”, “bid tendered”, “bidding/ tendering”, etc.) are synonymous, and day means calendar day. Singular also means plural.

2. Eligible Bidders

- 2.1 Bidders shall, as part of their bid, submit duly executed power of attorney authorizing the signatory of the bid to bind the bidder.
- 2.2 This invitation for bid is open to any bidder.
- 2.3 A bidder shall not be affiliated with a firm or entity
- (i) that has provided consulting services related-to the Works to the Employer during the preparatory stages of the Works or of the Project of which the Works form a part, or
 - (ii) that has been hired (or is proposed to be hired) by the Employer as Engineer/ Consultant for the contract.
- 2.4 The bidder shall not be under a declaration of ineligibility by Employer for corrupt or fraudulent practices as defined in ITB.
- 2.5 While evaluating the bids, pursuant to bid evaluation criteria in Global Notice of IFB, bidders and / or his sub-contractors past performance shall be assessed for ascertaining the responsiveness of the bid. In such case the decision of employer / consultant shall be final and binding on the bidder.
- 2.6 The bidder is not put on holiday by MNGL or black listed by any Government Department Public Sector.

3. Bid Evaluation Criteria:-

3.1 Technical

3.1.1 Experience Criteria - As per Annexure – I of IFB.

3.2 Financial - As per Annexure – I of IFB

- 3.3 Bidder shall not be affiliated with a firm or entity, (i) that has provided consulting services related to Works to Employer during preparatory stages of Works or of the Project of



**MAHARASHTRA NATURAL
GAS LIMITED**

**Tender for Bi-Annual Rate Contract for procurement of
stickers & Nozzle Holder for CNG Dispenser for MNGL,
Pune.**

Bid No.: MNGL/C&P/2018-19/45

- which the Works form a part, or (ii) that has been hired (or is proposed to be hired) by Employer as Engineer/ Consultant for the contract.
- 3.4 Bidder shall meet the technical, as well as, commercial qualification criteria as stated above. Bidder shall furnish necessary documentary evidence such as LOA Copy/ Audited Financial Statement along with the bid, to justify meeting the stipulated qualification criteria. In absence of requisite documents, MNGL reserve the right to reject the bid without making any reference to the bidder.
- 4. Bids from Consortium – Not applicable**
- 5. One Bid per Bidder**
- 5.1 A firm shall submit only one bid in the same bidding process. No firm can be a subcontractor while submitting a bid individually in the same bidding process. A firm, if acting in the capacity of subcontractor in any bid, may participate in more than one bid, but only in that capacity. A bidder who submits or participates in more than one bid will cause all the proposals in which the bidder has participated to be disqualified.
- 6. Cost of Bidding**
- 6.1 The bidder shall bear all costs associated with the preparation and submission of the bid, and MNGL will in no case, be responsible or liable for these costs, regardless of the conduct or outcome of the bidding process.
- 7. Deleted**
- B. BIDDING DOCUMENTS**
- 8. Content of Bidding Document**
- 8.1 The Bidding Documents/ Tender Documents should be read in conjunction with any addenda issued in accordance with ITB Clause 10.
- 8.2 The bidder is expected to examine all instructions, forms, terms and specifications in the bidding documents. The Invitation for Bids (IFB) together with all its attachments thereto, shall be considered to be read, understood and accepted by the bidders. Failure to furnish all information required by the bidding documents or submission of a bid not substantially responsive to the bidding documents in every respect will be at bidder's risk and may result in the rejection of his bid.
- 9. Clarification of Bidding Documents**
- 9.1 A prospective bidder requiring any clarification(s) of the Bidding Documents may notify MNGL in writing or by fax or e-mail at MNGL's mailing address indicated in the Invitation for Bids not later than 7 days prior to the deadline. MNGL may, if deem appropriate, respond in writing to the request for clarification. Written copies of MNGL's response (including an explanation of the query but without identifying the source of the query) will be sent to all prospective bidders who have received the bidding documents. Any Clarification or information required-by the bidder but same not received by the Employer, seven days prior to the bid due date, the same is liable to be considered as no clarification/information required.



**MAHARASHTRA NATURAL
GAS LIMITED**

**Tender for Bi-Annual Rate Contract for procurement of
stickers & Nozzle Holder for CNG Dispenser for MNGL,
Pune.**

Bid No.: MNGL/C&P/2018-19/45

[In pre-bid meeting conference, all questions/ queries should be referred to MNGL on or before scheduled date of pre-bid conference. The question/ queries received by MNGL prior to pre-bid conference will be addressed in the pre-bid conference & no separate communication will be sent to bidders]

10. Amendment of Bidding Documents

- 10.1 At any time prior to the bid due date, MNGL may, for any reason, whether at its own initiative or in response to a clarification requested by a prospective bidder, modify the bidding documents.
- 10.2 The amendment will be notified in writing or by fax or e-mail to all prospective bidders, at the address, fax numbers, e-mail id provided by the bidder, who have received the Bidding Documents and will be binding on them.
- 10.3 In order to afford prospective bidders, reasonable time in which to take the amendment into account in preparing their bids, MNGL may, at its discretion, extend the bid due date.

C. PREPARATION OF BIDS

11. Language of Bid

- 11.1 The bid prepared by the bidder and all-correspondence/drawings and documents relating to the bid exchanged by bidder and MNGL shall be written in English language. Any printed literature furnished by the bidder may be written in another language so long as accompanied by an ENGLISH translation duly authenticated by the chamber of commerce of Bidders country, in which case, for the purpose of interpretation of the bid, the ENGLISH translation shall govern. Metric measurement system shall be applied.

12. Documents Comprising the Bid

- 12.1 The bid prepared by the bidder shall comprise the following components:

- 12.2 Envelope -1: Super scribing Techno-Commercial Un-priced Bids (PART-I)

Part-I: Techno-commercial un-priced Bid (to be furnished in one original) and shall contain the following:

- i) Bidder's general/ details information as per format F-1.
- ii) Power of Attorney in favour of person(s) signing the bid that such person (s) is/are authorized to sign the bid on behalf of the bidder and any consequence resulting due to such signing shall be binding on the bidder.
- iii) Specific experience, annual turnover and equipment deployment details as called for in qualifying requirements.
- iv) A Bid Form as per format F-2.
- v) A confirmation that prices in requisite formats, strictly complying with the requirement, with prices blanked out, are in envelope number II "Price Bid".
- vi) Copy of Bid security in accordance with Clause 5A of IFB & Clause 16 of ITB to be furnished either in the form of Cashier's / Banker's cheque / Bank Draft payable to MNGL at Pune/ Bank Guarantee as per format F-4
- vii) Confirmation of no deviation as per Format F-6.



**MAHARASHTRA NATURAL
GAS LIMITED**

**Tender for Bi-Annual Rate Contract for procurement of
stickers & Nozzle Holder for CNG Dispenser for MNGL,
Pune.**

Bid No.: MNGL/C&P/2018-19/45

- viii) PF Registration
 - ix) ESI Registration
 - x) GST Registration
 - xi) Valid License, issued by Regional Labour Commissioner, Govt of India
- Note: All pages of the bid to be signed and sealed by authorized person of the bidder.
- 12.3 Envelope-II: Super scribing "Price Bid- Not to Open with Techno-Commercial Un-priced Bid" - PART-II
- Part-II - Price Bid
- i) Part-B shall contain one original of Schedule of Rates duly filled in, in separate sealed envelopes duly signed and stamped on each page super scribing on the sealed envelope "Price — Do Not Open". In case of any correction, the bidders shall put his signature and his stamp.
- 12.4 Envelope-III: Super scribing "EMD/Bid Security" - PART-III
- Part-III – EMD / Bid Security
- i) Part-III shall contain one original of EMD / Bid Security in the form of DD / BG in favour of Maharashtra natural Gas Ltd.,Pune, in separate sealed envelopes duly signed and stamped on each page super scribing on the sealed envelope "EMD / Bid Security".
13. **Bid Prices**
- 13.1 Unless stated otherwise in the Bidding Documents, the Contract shall be for the whole works as described in Bidding Document, based on the unit rates and prices submitted by the Bidder and accepted by the EMPLOYER.
- 13.2 Prices must be filled in format for 'Schedule of Rates' enclosed as part of Bidding Document. If quoted in separate typed sheets and any variation in item description, unit or quantity is noticed; the bid is liable to be rejected.
- 13.3 Bidder shall quote for all the items of Schedule of Rates after careful analysis of cost involved for the performance of the completed item considering all parts of the Bidding Document.
- 13.4 All taxes and duties shall be indicated.
- 13.5 Alternative bids shall not be considered.
14. **Bid Currencies – VOID**
15. **Bid Validity**
- 15.1 Bids shall be kept valid for 4 (four) months from the final bid due date.
- 15.2 In exceptional circumstances, prior to expiry of the original bid validity period, the Employer may request that the bidders extend the period of validity for a specified additional period. The request and the responses thereto shall be made in writing or by fax / e-mail. A bidder may refuse the request without forfeiture of his bid security. A



**MAHARASHTRA NATURAL
GAS LIMITED**

**Tender for Bi-Annual Rate Contract for procurement of
stickers & Nozzle Holder for CNG Dispenser for MNGL,
Pune.**

Bid No.: MNGL/C&P/2018-19/45

bidder agreeing to the request will not be required or permitted to modify his bid, but will be required to extend the validity of its bid security for the period of the extension and in accordance with Clause 16 in all respects.

16. Bid Security

16.1 Pursuant to Clause-5A, the bidder shall furnish, as part of his bid, bid security in the amount specified in the Invitation for Bids (IFB).

16.2 The bid security is required to protect MNGL against the risk of bidder's conduct which would warrant the security's forfeiture, pursuant to Clause-16.7

16.3 The bid security in Indian Rupees for bidders quoting in Indian currency shall be in the form of a Bank Draft/ Banker's Cheque/ Bank Guarantee.

MNGL shall not be liable to pay any bank charges, commission or interest on the amount of Bid Security.

In case Bid Security is in the form of a Bank Guarantee, the same shall be from any Indian scheduled bank or a branch of an International bank situated in India and registered with Reserve bank of India as scheduled foreign bank in case of Indian bidder and from any reputed International bank or Indian scheduled bank in case of foreign bidder. Bid Security shall be valid for 2 months beyond the validity of the Bid.

16.4 Any bid not secured in accordance with Clause-16.1 and 16.3 may be rejected by MNGL as non-responsive.

16.5 Unsuccessful bidder's bid security will be discharged/ returned as promptly as possible after award of contract and signing of agreement.

16.6 The successful bidder's bid security will be discharged upon the bidder's accepting the award & signing the Agreement, pursuant to Clause-39 and furnishing the Contract Performance Security pursuant to Clause-40.

16.7 The bid security may be forfeited:

- a) If a bidder withdraws his bid during the period of bid validity.
- b) in the case of a successful bidder, if the bidder fails:
 - i) to accept the Notification of Award / Fax of Intent (FOI) / Service Order (SO) or
 - ii) to furnish Contract Performance Security in accordance with Clause-40.
 - iii) to accept arithmetical corrections,

16.8 Bid Security should be in favour of Maharashtra Natural Gas Limited and addressed to MNGL. In case Bid Security is in the form of Bank Guarantee, the same must indicate the Bid Document and the work for which the bidder is quoting. This is essential to have proper co-relation at a later date. The Bid Security shall be in the form provided at F-4 (Bank Guarantee).

16.9 The Indian / Domestic firms registered with NSIC / MSME, under its single point registration scheme are exempted from furnishing Tender Fee & Bid Security, provided they are registered for the items / work they intend to quote and subject to their enclosing with their bid a copy of latest and current registration certificate.



**MAHARASHTRA NATURAL
GAS LIMITED**

**Tender for Bi-Annual Rate Contract for procurement of
stickers & Nozzle Holder for CNG Dispenser for MNGL,
Pune.**

Bid No.: MNGL/C&P/2018-19/45

17. Pre-Bid Meeting – As per Clause VI of IFB

- 17.1 The bidder(s) or his designated representative, who have purchased bid document, are invited to attend a pre-bid meeting which will take place as indicated in IFB
- 17.2 The purpose of the meeting will be to clarify issues and to answer questions on any matter that may be raised at that stage.
- 17.3 Text of the questions raised and the responses given, together with any responses prepared after the meeting, will be transmitted without delay (without identifying the sources of the question) to all purchasers of the bidding documents. Any modification of the bidding documents listed in ITB Sub-Clause 8.1 that may become necessary as a result of the pre-bid meeting shall be made by the Employer exclusively through the issue of an Addendum pursuant to Clause 10 and not through the minutes of the pre-bid meeting.
- 17.4 Non-attendance of the pre-bid meeting will not be a cause for disqualification of a bidder.

18. Format and Signing of Bid

- 18.1 The original of the bid shall be typed or written in indelible ink and shall be signed by a person or persons duly authorized to sign on behalf of the bidder. The name and position held by each person signing, must be typed or printed below the signature. All pages of the bid except for unamended printed literature where entries or amendments have been made shall be initialed by the person or persons signing the bid.
- 18.2 The bid shall contain no alterations, omissions, or additions, unless such corrections are initialed by the person or persons signing the bid.

19. Zero Deviation

- 19.1 Bidders shall note that if any deviation are taken to the under mentioned provisions of Bid Document by the Bidder the bid is liable to be rejection.
- i) Do not meet BEC Criteria
 - ii) Bid Security
 - iii) Performance Security (Contract Performance Bank Guarantee), 10% of Annualized Contract/Order value
 - iv) Delivery Period
 - v) Terms of Payment
 - vi) Force Majeure
 - vii) Resolution of Dispute/Arbitration
 - viii) Termination of Contract,
 - ix) Warranty and Guarantee
 - x) Offer not submitted for complete scope of work
 - xi) Firm prices
 - xii) Prices not quoted as per Schedule of Rates formats.
 - xiii) Bidder have been banned by Government of India or any its Agency/ Undertaking/ Department of Government of India.
 - xiv) Bidder is under liquidation.
 - xv) Bidder is under litigation which owner's considers a disqualification.
 - xvi) Bids not conforming to technical specification/requirements.



**MAHARASHTRA NATURAL
GAS LIMITED**

**Tender for Bi-Annual Rate Contract for procurement of
stickers & Nozzle Holder for CNG Dispenser for MNGL,
Pune.**

Bid No.: MNGL/C&P/2018-19/45

- xvii) Any other such provisions if specifically stipulated elsewhere in the Bid Document.
xviii) Price Reduction Schedule.

However, MNGL reserve the right to request the bidder to withdraw the deviations against above mentioned provisions of Bid Documents.

20. Mode of Payment

Maharashtra Natural Gas Limited will issue A/C payee cheque for payment payable at par, in case work is awarded to bidder.

21. Agent/ consultant/ Representative/ Retainer/ Associate - VOID

D. SUBMISSION OF BIDS

22. Sealing and Marking of Bids

22.1 Bid shall be submitted in the following manner in separately sealed envelopes duly super scribed as below:

- Part-I - Techno-commercial/ unpriced Bid
- Part-II - Priced Bid
- Part III - Original Bid Security

22.2 Part-I shall contain original of UNPRICED BID complete with all technical and commercial details other than price (with prices blanked out and copy of bid security). The unpriced bid shall be enclosed in separately sealed envelopes duly marked and addressed to the Employer. The envelope shall also indicate the name of the bidder.

22.3 Part-II - PRICED BID shall be submitted in one original with duly filled in Price schedule sealed in a separate envelope duly marked and addressed to the Employer.

22.4 Part-III - BID SECURITY/Tender Fees in original shall be submitted sealed in a separate envelope duly marked and addressed to the Employer.

22.5 The three envelopes containing PART-I, PART-II and PART-III should be enclosed in a larger envelope duly sealed and marked and also bear the name and address of the Bidder and Tender No.

22.6 If the outer envelope is not sealed and marked properly, MNGL will assume no responsibility for the Bid's misplacement or premature opening.

22.7 Each bidder shall submit only one bid. A bidder who submits more than one bid will be rejected.

23. Deadline for Submission of Bids

23.1 Bids must be received by MNGL at the address specified in the Invitation for Bids (IFB) not later than the date and time stipulated in the IFB.

23.2 MNGL may, in exceptional circumstances and at its discretion, on giving reasonable notice by fax or any written communication to all prospective bidders who have been issued the bid documents, extend the deadline for submission of bids, in which case all

 MAHARASHTRA NATURAL GAS LIMITED	<u>Tender for Bi-Annual Rate Contract for procurement of stickers & Nozzle Holder for CNG Dispenser for MNGL, Pune.</u> Bid No.: MNGL/C&P/2018-19/45
---	---

rights and obligations of MNGL and the bidders, previously subject to the original deadline will thereafter be subject to the deadline as extended.

24. Late Bids

24.1 Any bid received by MNGL after the deadline for submission of bids prescribed on main body of IFB will be rejected and returned unopened to the bidder. However MNGL reserve the right to consider late bid under special conditions.

25. Modification and Withdrawal of Bids

25.1 The bidder may modify or withdraw his bid after the bid submission but before the due date for submission, provided that written notice of the modification/ withdrawal is received by MNGL prior to the deadline for submission of bids.

25.2 The modification shall also be prepared, sealed, marked and dispatched in accordance with the provisions of Clause 22, with the outer and inner envelopes additionally marked "modification" or "withdrawal", as appropriate. A withdrawal notice may also be sent by telex or cable, but followed by a signed confirmation copy post marked not later than the deadline for submission of bids.

25.3 No bid shall be modified after the deadline for submission of bids.

25.4 No bid shall be allowed to be withdrawn in the interval between the deadline for submission of bids and the expiration of the period of bid validity specified by the bidder on the Bid Form. Withdrawal of a bid during this interval shall result in the bidder's forfeiture of his bid security pursuant to Sub-Clause 16.7.

E. BID OPENING AND EVALUATION

26. Bid Opening

26.1 Unpriced Bid Opening (Part –I & Part – III)

MNGL will open bids, including withdrawals and modifications made pursuant to Clause 25, in the presence of bidders' designated representatives who choose to attend, at date, time and location stipulated in the IFB. The bidders' representatives, who are present, shall sign a bid opening register evidencing their attendance.

26.2 Priced Bid Opening (Part –II)

26.2.1 MNGL will open the price bids of those bidders who meet the qualification requirement and whose bids are determined to be technically and commercially responsive. Bidders selected for opening of their price bids shall be informed about the date of price bid opening. Bidders may depute their authorized representative to attend the opening. The bidders' representatives, who are present, shall sign a register evidencing their attendance.

26.2.2 The price bids of those bidders who were not found to be techno-commercially responsive shall be returned unopened after opening of the price bids of techno-commercially responsive bidders.

27. Process to be Confidential



**MAHARASHTRA NATURAL
GAS LIMITED**

**Tender for Bi-Annual Rate Contract for procurement of
stickers & Nozzle Holder for CNG Dispenser for MNGL,
Pune.**

Bid No.: MNGL/C&P/2018-19/45

- 27.1 Information relating to the examination, clarification, evaluation and comparison of bids, and recommendations for the award of a contract, shall not be disclosed to bidders or any other persons officially concerned with such process. Any effort by a bidder to influence the Employer's processing of bids or award decisions may result in the rejection of the bidder's bid.
28. **Contacting the Employer**
- 28.1 From the time of bid opening to the time of Contract award, if any bidder wishes to contact the Employer on any matter related to the bid, it should do so in writing.
- 28.2 Any effort by the bidder to influence the Employer in the Employer's bid evaluation, bid comparison, or Contract award decisions may result in the rejection of the bidder's bid.
29. **Examination of bids and Determination of Responsiveness**
- 29.1 Prior to the detailed evaluation of bids, the Employer will determine whether each bid
- meets the Bid Evaluation Criteria;
 - has been properly signed;
 - is accompanied by the required securities;
 - is substantially responsive to the requirements of the bidding documents; and
 - provides any clarification and/ or substantiation that the Employer may require to determine responsiveness pursuant to Sub-Clause 29.2.
- 29.2 A substantially responsive bid is one which conforms to all the terms, conditions and specifications of the bidding documents without material deviations or reservations. A material deviation or reservation is one
- that affects in any substantial way the scope, quality, or performance of the Works;
 - that limits in any substantial way, inconsistent with the bidding documents, the Employer's rights or the bidder's obligations under the contract; or
 - whose rectification would affect unfairly the competitive position of other bidders presenting substantially responsive bids.
- 29.3 If a bid is not substantially responsive, it will be rejected by the Employer and may not subsequently be made responsive by correction or withdrawal of the nonconforming deviation or reservation.
30. **Correction of Errors**
- 30.1 Bids determined to be substantially responsive will be checked by the Employer for any arithmetic errors. Errors will be corrected by the Employer as follows:
- where there is a discrepancy between the amounts in words and in figures, the amount in words will govern; and
 - where there is a discrepancy between the unit rate and the total resulting from multiplying the unit rate by the quantity, the unit rate as quoted will govern.
- 30.2 The amount stated in the bid will be adjusted by the Employer in accordance with the above procedure for the correction of errors and, with the concurrence of the bidder, shall be considered as binding upon the bidder. If the bidder does not accept the corrected amount of bid, its bid will be rejected, and the bid security shall be forfeited.



**MAHARASHTRA NATURAL
GAS LIMITED**

**Tender for Bi-Annual Rate Contract for procurement of
stickers & Nozzle Holder for CNG Dispenser for MNGL,
Pune.**

Bid No.: MNGL/C&P/2018-19/45

31. **Conversion to Single Currency for Comparison of Bids – Not applicable**
32. **Evaluation and Comparison of Bids**
- 32.1 The evaluation and comparison of bids will be done as per the provisions of the bid evaluation criteria on overall basis.
33. **Preference for Domestic Bidders - VOID**
34. **Purchase Preference - VOID**
35. **Compensation for extended stay - Not Applicable**
- F. AWARD OF CONTRACT**
36. **Award**
- 36.1 Subject to Clause 29, MNGL will award the contract to the successful bidder whose bid has been determined to be substantially responsive and has been determined as the lowest, is determined to be qualified to satisfactorily perform the contract.
37. **Employer's Right to Accept Any Bid and to reject any or all Bids**
- 37.1 MNGL reserves the right to accept or reject any bid, and to annul the bidding process and reject all bids, at any time prior to award of contract, without thereby incurring any liability to the affected bidder or bidders or any obligations to inform the affected bidder or bidders of the ground for MNGL'S ACTION.
38. **Notification of Award**
- 38.1 Prior to the expiration of period of bid validity MNGL will notify the successful bidder in writing by fax, cable or telex to be confirmed in writing, that his bid has been accepted. The notification of award/ Fax of Intent / Service Order will constitute the formation of the Contract.
- 38.2 Delivery/ completion period shall be counted from the date of notification of award / Fax of Intent / Service Order.
- The notification of award will constitute the formation of a Contract, until the Contract has been effected pursuant to signing of Contract as per Clause 39 of ITB.
- Upon the successful bidder's furnishing of contract performance security, pursuant to Clause 40 of ITB, MNGL will promptly notify each unsuccessful bidder and will discharge his bid security, pursuant to Clause 16 of ITB.
39. **Signing of Agreement**
- 39.1 MNGL will award the Contract to the successful bidder, who, within 15 days of receipt of the same, shall sign and return the acceptance copy to MNGL.
- 39.2 The successful bidder shall be required to execute an AGREEMENT in the proforma given in of this standard bidding document on non-judicial paper of appropriate value (the



**MAHARASHTRA NATURAL
GAS LIMITED**

**Tender for Bi-Annual Rate Contract for procurement of
stickers & Nozzle Holder for CNG Dispenser for MNGL,
Pune.**

Bid No.: MNGL/C&P/2018-19/45

cost of stamp paper shall be borne by the Contractor), within 15 days of the receipt by him of the Notification of Acceptance of Tender. In the event of failure on the part of the successful bidder to sign the AGREEMENT within the above stipulated period, the Bid Security shall be forfeited and the acceptance of the tender shall be considered as cancelled.

40. Contract Performance Security

40.1 Within 15 days of the receipt of the notification of award/ Fax of Intent / Service Order from MNGL, the successful bidder shall furnish the contract performance security in the form provided in the bidding documents. The Contract Performance Security shall be in the form of either Banker's Cheque or Demand Draft or Bank Guarantee and shall be in the currency of the Contract.

40.2 The contract performance security shall be for an amount equal to 10% of the annualized value of the contract towards faithful performance of the contractual obligations and performance of equipment. This Bank Guarantee/ DD shall be from any Indian scheduled bank or a branch of an International bank situated in India and registered with Reserve bank of India as scheduled foreign bank. **This Bank Guarantee shall be valid for a period of 3 months beyond the completion period of the contract.**

40.3 Failure of the successful bidder to comply with the requirements of this article shall constitute sufficient grounds for the annulment of the award and forfeiture of the bid security, in which event MNGL may award the order to the next lowest evaluated bidder or call for new bids.

41. Corrupt or Fraudulent Practices

41.1 MNGL requires that bidders/ contractors observe the highest standard of ethics during the execution of contracts. In pursuance of this policy, the Employer:

- a) defines, for the purposes of this provision, the terms set forth below as follows:
 - i) "corrupt practice" means the offering, giving or soliciting of anything of value to influence the action of a public official in the procurement process or in contract execution; and
 - ii) "fraudulent practice" means a misrepresentation of facts in order to influence a procurement process or the execution of a contract to the detriment of the Employer, and includes collusive practice among bidders (prior to or after bid submission) designed to establish bid prices at artificial non-competitive levels and to deprive the Employer of the benefits of free and open competition;
- b) will reject a proposal for award if it determines that the bidder recommended for award has engaged in corrupt or fraudulent practices in competing for the contract in question;
- c) will declare a firm ineligible and put on holiday, either indefinitely or for a stated period of time if it at any time determines that the firm has engaged in corrupt or fraudulent practices in competing for, or in executing a contract.



**MAHARASHTRA NATURAL
GAS LIMITED**

**Tender for Bi-Annual Rate Contract for procurement of
stickers & Nozzle Holder for CNG Dispenser for MNGL,
Pune.**

Bid No.: MNGL/C&P/2018-19/45

2.0 ANNEXURE TO INSTRUCTIONS TO BIDDERS (ITB)



**MAHARASHTRA NATURAL
GAS LIMITED**

**Tender for Bi-Annual Rate Contract for procurement of
stickers & Nozzle Holder for CNG Dispenser for MNGL,
Pune.**

Bid No.: MNGL/C&P/2018-19/45

CONTENTS

Sl. No.	Description
1)	Annexure -I : List of Formats
2)	Annexure -II : Commercial Questionnaire
3)	Annexure-III : Check List



**MAHARASHTRA NATURAL
GAS LIMITED**

**Tender for Bi-Annual Rate Contract for procurement of
stickers & Nozzle Holder for CNG Dispenser for MNGL,
Pune.**

Bid No.: MNGL/C&P/2018-19/45

LIST OF FORMATS

{Annexure – I TO Instruction to Bidder (ITB)}



**MAHARASHTRA NATURAL
GAS LIMITED**

**Tender for Bi-Annual Rate Contract for procurement of
stickers & Nozzle Holder for CNG Dispenser for MNGL,
Pune.**

Bid No.: MNGL/C&P/2018-19/45

CONTENT

Sl. No.	Description
1)	F-1 : Bidder's General Information
2)	F-1A : Detail information about bidder
3)	F-2 : Bid Form
4)	F-3 : List of Enclosures
5)	F-3A : Financial Detail
6)	F-4 : Proforma for Bank Guarantee for EMD/ Bid Security • Instruction for Furnishing Bid Guarantee/ Bank Guarantee
7)	F-5 : Letter of Authority
8)	F-6 : No Deviation Confirmation
9)	F-7 : Certificate
10)	F-8 : Details of Similar Work done during past five years
11)	F-9 : Present commitments of the Bidder
12)	F-10 : Proforma of Bank Guarantee for Contract Performance Security



**MAHARASHTRA NATURAL
GAS LIMITED**

**Tender for Bi-Annual Rate Contract for procurement of
stickers & Nozzle Holder for CNG Dispenser for MNGL,
Pune.**

Bid No.: MNGL/C&P/2018-19/45

**F-1
BIDDER'S GENERAL INFORMATION**

To
M/s Maharashtra Natural Gas Limited
Plot No. 27, 1st Floor,
Narveer Tanakiwadi PMPML Bus Depot Commercial Building,
Shivajinagar, Pune - 411005

- 1.1 Bidder Name : _____
- 1.2 Number of Years in Operation : _____
- 1.3 Registered Address : _____

- 1.4 Operation Address : _____
if different from above _____
- 1.5 Telephone Number : _____
(Country Code) (Area Code) (Telephone No.)
- 1.6 E-mail address & Web Site : _____
- 1.7 Telefax Number : _____
(Country Code) (Area Code) (Telephone No.)
- 1.8 ISO Certification, if any : {If yes, please furnish details}

(SIGNATURE OF BIDDER WITH SEAL)



**MAHARASHTRA NATURAL
GAS LIMITED**

**Tender for Bi-Annual Rate Contract for procurement of
stickers & Nozzle Holder for CNG Dispenser for MNGL,
Pune.**

Bid No.: MNGL/C&P/2018-19/45

**F-1A
DETAILED INFORMATION ABOUT BIDDERS**

1. IN CASE OF INDIVIDUAL
 - 1.1 Name of Business
 - 1.2 Whether his business is registered
 - 1.3 Date of commencement of business
 - 1.4 Whether he pays Income Tax over Rs.10,000/- per year
2. IN CASE OF PARTNERSHIP
 - 2.1 Name of Partners
 - 2.2 Whether the partnership is registered
 - 2.3 Date of establishment of firm
 - 2.4 If each of partners of the firm pays Income Tax over Rs.10,000/- per year and if so, which of them pays the same.
3. IN CASE OF LIMITED LIABILITY COMPANY OR COMPANY LIMITED BY GUARANTEE
 - 3.1 Amount of paid up capital
 - 3.2 Name of Directors
 - 3.3 Date of Registration of Company
 - 3.4 Copies of the balance sheet of the company of the last three years.

(SEAL AND SIGNATURE OF BIDDER)



**MAHARASHTRA NATURAL
GAS LIMITED**

**Tender for Bi-Annual Rate Contract for procurement of
stickers & Nozzle Holder for CNG Dispenser for MNGL,
Pune.**

Bid No.: MNGL/C&P/2018-19/45

**F-2
BID FORM**

To
M/s Maharashtra Natural Gas Limited
Plot No. 27, 1st Floor,
Narveer Tanakiwadi PMPML Bus Depot Commercial Building,
Shivajinagar, Pune - 411005

Dear Sir,

After examining/ reviewing the Bidding Documents for **Bi-Annual Rate Contract for procurement of stickers & Nozzle Holder for CNG Dispenser for MNGL, Pune** including technical specifications, drawings, General and Special Conditions of Contract and schedule of rates etc. The receipt of which is hereby duly acknowledged, we, the undersigned, pleased to offer to execute the whole of the Job of **contract shall be 2 (two) years from the date service order, further extendable for another 1 (one) year on the same terms & conditions** and in conformity with, the said Bid Document, including Addenda Nos. (if any).

We confirm that this bid is valid for a period of four (4) months from the date of opening of Techno-commercial Bid, and it shall remain binding upon us and may be accepted by any time before the expiration of that period.

If our bid is accepted, we will provide the performance security equal to **10% (ten percent) of the total Contract Price**, for the due performance with in fifteen days of such award.

Until a final Agreement is prepared and executed, the bid together with your written acceptance thereof in your notification of award shall constitute a binding Agreement between us.

We understand that Bid Document is not exhaustive and any action and activity not mentioned in Bid Documents but may be inferred to be included to meet the intend of the Bid Documents shall be deemed to be mentioned in Bid Documents unless otherwise specifically excluded and we confirm to perform for fulfillment of Agreement and completeness of the Work in all respects within the time frame and agreed price.

We understand that you are not bound to accept the lowest priced or any bid that you may receive.

SEAL AND SIGNATURE
DATE: _____

Duly authorized to sign bid for and on behalf of _____

(SIGNATURE OF WITNESS)
WITNESS NAME:
ADDRESS:



**MAHARASHTRA NATURAL
GAS LIMITED**

**Tender for Bi-Annual Rate Contract for procurement of
stickers & Nozzle Holder for CNG Dispenser for MNGL,
Pune.**

Bid No.: MNGL/C&P/2018-19/45

**F-3
LIST OF ENCLOSURES**

To,
Maharashtra Natural Gas Limited
Plot No. 27, 1st Floor,
Narveer Tanakiwadi PMPML Bus Depot Commercial Building,
Shivajinagar, Pune - 411005

Dear Sir,

We are enclosing the following documents as part of the bid:

1. Power of Attorney of the signatory to the Bidding Document.
2. Document showing annual turnover for the last three years such as annual reports, profit and loss account, net worth etc. along with information as sought in enclosed format F-3A.
3. Organization chart of the bidder and the structure assigned for execution of the work under this bid.
4. Copy of Bidding Documents along with addendum/ corrigendum no. duly signed and sealed on each page, in token of confirmation that Bid Documents are considered in full while preparing the bid and in case of award, work will be executed in accordance with the provisions detailed in Bid Documents.

(SEAL AND SIGNATURE OF BIDDER)



**MAHARASHTRA NATURAL
GAS LIMITED**

**Tender for Bi-Annual Rate Contract for procurement of
stickers & Nozzle Holder for CNG Dispenser for MNGL,
Pune.**

Bid No.: MNGL/C&P/2018-19/45

**F-3A
FINANCIAL DETAIL**

EACH BIDDER MUST FILL IN THIS FORM

a) Annual Turnover data for the last 3 years.

Year	Currency	Amount	Ex. Rate (*)	Amount (INR) (*)
Year 1				
Year 2				
Year 3				

1. The information supplied should be the Annual Turnover of the Bidder.
2. A brief note should be appended describing thereby details of turnover along with audited balance sheet with profit & loss account statement for the last 3 years.

b) Annual Net-worth data for the last 3 years.

Year	Currency	Amount	Ex. Rate (*)	Amount (INR) (*)
Year 1				
Year 2				
Year 3				

1. Net Worth = Reserves + Capitals – Accumulated Loss

(SEAL AND SIGNATURE OF BIDDER)

(*) To be filled by Employer



MAHARASHTRA NATURAL GAS LIMITED

Tender for Bi-Annual Rate Contract for procurement of stickers & Nozzle Holder for CNG Dispenser for MNGL, Pune.

Bid No.: MNGL/C&P/2018-19/45

Sheet 1 of 2

F-4

PROFORMA FOR BANK GUARANTEE FOR EARNEST MONEY DEPOSIT/ BID SECURITY
(To be stamped in accordance with the Stamp Act)

Ref:

Bank Guarantee No.
Date

To
Maharashtra Natural Gas Limited,
Plot No. 27, 1st Floor,
Narveer Tanakiwadi PMPML Bus Depot Commercial Building,
Shivajinagar, Pune - 411005

Dear Sir(s),

In accordance with Letter Inviting Tender under your reference No. _____ M/s _____ having their Registered/ Head Office at _____ (hereinafter called the Tenderer) wish to participate in the said tender for _____

As an irrevocable Bank Guarantee against Earnest Money for the amount of _____ is required to be submitted by the Tenderer as a condition precedent for participation in the said tender which amount is liable to be forfeited on the happening of any contingencies mentioned in the Tender Document.

We, the _____ Bank at _____ having our Head Office _____ (Local Address) guarantee and undertake to pay immediately on demand without any recourse to the tenderers by Maharashtra Natural Gas Limited the amount _____ without any reservation, protest, demur and recourse. Any such demand made by MNGL, shall be conclusive and binding on us irrespective of any dispute or difference raised by the Tenderer.

This guarantee shall be irrevocable and shall remain valid up to _____ [this date should be 6 months after the date finally set out for closing of tender]. If any further extension of this guarantee is required, the same shall be extended to such required period on receiving instructions from M/s _____ whose behalf this guarantee is issued.

In witness whereof the Bank, through its authorized officer, has set its hand and stamp on this _____ day of _____ 2018 at _____.

WITNESS:

(SIGNATURE)
(NAME)

(OFFICIAL ADDRESS)

(SIGNATURE)
(NAME)
Designation with Bank Stamp
Attorney as per
Power of Attorney No. _____
Date: _____



**MAHARASHTRA NATURAL
GAS LIMITED**

**Tender for Bi-Annual Rate Contract for procurement of
stickers & Nozzle Holder for CNG Dispenser for MNGL,
Pune.**

Bid No.: MNGL/C&P/2018-19/45

Sheet 2 of 2

**INSTRUCTIONS FOR FURNISHING BID-GUARANTEE/
BANK GUARANTEE**

1. The Bank Guarantee by bidders will be given on non-judicial stamp paper as per stamp duty applicable. The non-judicial stamp paper should be in the name of the issuing bank. In case of foreign bank, the said banks guarantee to be issued by its correspondent bank in India on requisite non-judicial stamp paper.
2. The expiry date as mentioned in bid document should be arrived at by adding 2 months to the date of expiry of the bid validity unless otherwise specified in the Bid Documents.
3. The bank guarantee by bidders will be given from bank as specified in ITB
4. A letter from the issuing bank of the requisite Bank Guarantee confirming that said bank guarantee/ all future communication relating to the Bank Guarantee shall be forwarded to the Employer at its address as mentioned at ITB.
5. Bidders must indicate the full postal address of the bank along with the bank's E-mail/ Fax. from where the earnest money bond has been issued.



**MAHARASHTRA NATURAL
GAS LIMITED**

**Tender for Bi-Annual Rate Contract for procurement of
stickers & Nozzle Holder for CNG Dispenser for MNGL,
Pune.**

Bid No.: MNGL/C&P/2018-19/45

**F-5
LETTER OF AUTHORITY
PROFORMA FOR LETTER OF AUTHORITY FOR ATTENDING AND SUBSEQUENT
NEGOTIATIONS/CONFERENCES**

No.:

Date:

To,
Maharashtra Natural Gas Limited,
Plot No. 27, 1st Floor,
Narveer Tanakiwadi PMPML Bus Depot Commercial Building,
Shivajinagar, Pune - 411005

Dear Sir,

We _____ hereby authorize following representative(s) to attend un-priced bid opening and price bid opening and for any other correspondence and communication against above Bidding Document:

1) Name & Designation _____ Signature _____

2) Name & Designation _____ Signature _____

We confirm that we shall be bound by all commitments made by aforementioned authorized representatives.

Yours faithfully,

Signature

Name & Designation

For and on behalf of

Note: This letter of authority should be on the letterhead of the bidder and should be signed by a person competent and having the power of attorney to bind the bidder.

Not more than two persons are permitted to attend techno-commercial un-priced and price bid opening.

 MAHARASHTRA NATURAL GAS LIMITED	<u>Tender for Bi-Annual Rate Contract for procurement of stickers & Nozzle Holder for CNG Dispenser for MNGL, Pune.</u> Bid No.: MNGL/C&P/2018-19/45
---	---

**F-6
NO DEVIATION CONFIRMATION**

(Tender/ Bid Document No. _____)

EXCEPTION AND DEVIATION STATEMENT

NAME OF WORK:

BID DOCUMENT NO. :

Bidder may stipulate exceptions and deviations to Bid Document, if considered unavoidable as per the following format:

SL. NO.	CLAUSE NO.	PAGE NO. OF TENDER DOCUMENT	DEVIATION	REASONS FOR DEVIATION

Any exceptions / deviations brought out by us elsewhere in our Offer shall not be considered as valid and should be ignored by the Owner.

NAME OF BIDDER: _____

SIGNATURE OF BIDDER: _____
& SEAL



**MAHARASHTRA NATURAL
GAS LIMITED**

**Tender for Bi-Annual Rate Contract for procurement of
stickers & Nozzle Holder for CNG Dispenser for MNGL,
Pune.**

Bid No.: MNGL/C&P/2018-19/45

**F-7
CERTIFICATE**

To,
Maharashtra Natural Gas Limited,
Plot No. 27, 1st Floor,
Narveer Tanakiwadi PMPML Bus Depot Commercial Building,
Shivajinagar, Pune - 411005

Dear Sir,

If, we become a successful bidder and pursuant to the provisions of the Bidding Documents and contract is awarded to us the following certificate shall be automatically enforceable:

"We agree and acknowledge that the Employer is entering into the Agreement solely on its own behalf and not on behalf of any other person or entity. In particular, it is expressly understood and agreed that the Government of India is not a party to the Agreement and has no liabilities, obligations or rights there under. It is expressly understood and agreed that the Employer is authorized to enter into Agreement, solely on its own behalf under the applicable laws of India. We expressly agree, acknowledge and understand that the Employer is not an agent, representative or delegate of the Government of India. It is further understood and agreed that the Government of India is not and shall not be liable for any acts, omissions, commissions, breaches or other wrongs arising out of the Agreement. Accordingly, we hereby expressly waive, release and forego any and all actions or claims, including cross claims, VIP claims or counterclaims against the Government of India arising out of the Agreement and covenants not to sue to Government of India as to any manner, claim, cause of action or things whatsoever arising of or under the Agreement."

(SEAL AND SIGNATURE OF BIDDER)



**MAHARASHTRA NATURAL
GAS LIMITED**

**Tender for Bi-Annual Rate Contract for procurement of
stickers & Nozzle Holder for CNG Dispenser for MNGL,
Pune.**

Bid No.: MNGL/C&P/2018-19/45

F-8

DETAILS OF SIMILAR WORK DONE DURING PAST FIVE YEARS

Description of the work	Location of the work	Full Post Address and Phone nos. of Client & Name of Officer-in charge	Value of Contract	Date of Commencement of work	Scheduled Completion Time (Months)	Date of Actual Completion	Reasons for delay in project completion, if any

Note: Copies of letter of award and completion certificate for the above works to be enclosed.

The work completed earlier than three years need not be indicated here.

The list of work, not of similar nature need not be indicated here.

Failing to comply aforementioned instructions may lead to rejection of bid.

(SEAL AND SIGNATURE OF BIDDER)



**MAHARASHTRA NATURAL
GAS LIMITED**

**Tender for Bi-Annual Rate Contract for procurement of
stickers & Nozzle Holder for CNG Dispenser for MNGL,
Pune.**

Bid No.: MNGL/C&P/2018-19/45

F-9

PRESENT COMMITMENTS OF THE BIDDER

Full Postal Address and phone nos. of Client & Name of Officer-in-charge	Description of Work	Date of Commencement of Work	Scheduled Completion Period	%Age Completion as on Date	Expected Date of Completion	Remarks

Note: This list must be a full list of all type of works in hand

(SEAL AND SIGNATURE OF BIDDER)



**MAHARASHTRA NATURAL
GAS LIMITED**

**Tender for Bi-Annual Rate Contract for procurement of
stickers & Nozzle Holder for CNG Dispenser for MNGL,
Pune.**

Bid No.: MNGL/C&P/2018-19/45

Sheet 1 of 2

F-10

**PROFORMA OF BANK GUARANTEE FOR CONTRACT PERFORMANCE SECURITY
(ON NON-JUDICIAL PAPER OF APPROPRIATE VALUE)**

TO:

M/s Maharashtra Natural Gas Limited
Plot No. 27, 1st Floor,
Narveer Tanakiwadi PMPML Bus Depot Commercial Building,
Shivajinagar, Pune - 411005

Dear Sir,

M/s _____ have been awarded the work of
_____ for Maharashtra Natural Gas Limited, PUNE vide
Letter of Award No. _____ dated _____.

The Contracts conditions provide that the CONTRACTOR shall pay a sum of Rs. _____
(Rupees _____) as
full Contract Performance Guarantee in the form therein mentioned. The form of payment of
Contract Performance Guarantee includes guarantee executed by Nationalized Bank,
undertaking full responsibility to indemnify Maharashtra Natural Gas Limited, in case of default.

The said _____ has approached us
and at their request and in consideration of the premises we _____ having our office at
_____ have agreed to give such guarantee as hereinafter
mentioned.

1. We _____ hereby undertake and agree with
you that if default shall be made by M/s _____
in performing any of the terms and conditions of the tender or in payment of any money
payable to Maharashtra Natural Gas Limited we shall on demand pay without any
recourse to the contractor to you in such manner as you may direct the said amount of
Rupees _____ only or such portion thereof not exceeding
the said sum as you may from time to time require.
2. You will have the full liberty without reference to us and without affecting this guarantee,
postpone for any time or from time to time the exercise of any of the powers and rights
conferred on you under the contract with the said _____
_____ and to enforce or to forbear from endorsing any
powers or rights or by reason of time being given to the said
_____ which under law relating to the sureties would but for
provision have the effect of releasing us.
3. Your right to recover the said sum of Rs. _____
(Rupees _____) from us in manner aforesaid will not
be affected or suspended by reason of the fact that any dispute or disputes have been
raised by the said M/s _____ and/ or that any dispute or
disputes are pending before any officer, tribunal or court.



**MAHARASHTRA NATURAL
GAS LIMITED**

**Tender for Bi-Annual Rate Contract for procurement of
stickers & Nozzle Holder for CNG Dispenser for MNGL,
Pune.**

Bid No.: MNGL/C&P/2018-19/45

Sheet 2 of 2

4. The guarantee herein contained shall not be determined or affected by the liquidation or winding up dissolution or changes of constitution or insolvency of the said but shall in all respects and for all purposes be binding and operative until payment of all money due to you in respect of such liabilities is paid.
5. This guarantee shall be irrevocable and shall remain valid up to _____ If any further extension of this guarantee is required, the same shall be extended to such required period on receiving instruction from M/s _____ on whose behalf this guarantee is issued.
6. The Bank Guarantee's payment of an amount is payable on demand and in any case within 48 hours of the presentation of the letter of invocation of Bank Guarantee. Any dispute arising out of or in relation to the said Bank Guarantee shall be subject to the jurisdiction of Pune or High Court of Mumbai.
7. We have power to issue this guarantee in your favour under Memorandum and Articles of Association and the undersigned has full power to do under the Power of Attorney dated _____ granted to him by the Bank.

Yours faithfully,

_____ Bank

By its Constituted Attorney

Signature of a person duly
authorized to sign on behalf of
the Bank.



**MAHARASHTRA NATURAL
GAS LIMITED**

**Tender for Bi-Annual Rate Contract for procurement of
stickers & Nozzle Holder for CNG Dispenser for MNGL,
Pune.**

Bid No.: MNGL/C&P/2018-19/45

COMMERCIAL QUESTIONNAIRE

{Annexure – II to Instruction to Bidder (ITB)}



**MAHARASHTRA NATURAL
GAS LIMITED**

**Tender for Bi-Annual Rate Contract for procurement of
stickers & Nozzle Holder for CNG Dispenser for MNGL,
Pune.**

Bid No.: MNGL/C&P/2018-19/45

COMMERCIAL QUESTIONNAIRE

Note:

- 1) The Bidder shall submit reply to each query.
- 2) The bidder's reply/ confirmation as furnished in the Commercial Questionnaire (CQ) shall supercede the stipulation mentioned else where in the Bid.

Sl. No.	MNGL's Query	Bidder's Reply/ Confirmation
1.	Confirm that your Bid is valid for 4(four) month from the last date of submission of Bid.	
2.	Confirm that all details in unpriced part have been submitted in 1 Original. Bidding Document and drawings, signed and stamped on each page shall be submitted in original.	
3.	Confirm that the following documents are submitted with Part-I :	
i)	All documents in relevant Section as per CHECK LIST.	
ii)	Schedule of Rates/ Prices without specifying the rates/ prices are submitted in unpriced part, exactly as per the priced portion submitted in Part-II. In case some of items have not been quoted, such items should be identified in blank price format.	
iii)	Addendum duly signed and stamped on each page as a token of acceptance (applicable if issued).	
4.	Confirm that price has been submitted in 1 ORIGINAL only in a separately sealed envelope super scribing "PRICE PART"	
5.	Rates/ amount must be filled in format for 'Schedule of Rates' enclosed as part of Bidding Document. If quoted in separate typed sheets and any variation in item description, unit or quantity is noticed, the bid is liable to be rejected. In any case, Bidder shall be presumed to have quoted against the tendered description of work and the same shall be binding on the Bidder. Please confirm.	
6.	Confirm that deviation/ terms & conditions are not mentioned in the price part. In case any terms and condition is mentioned in the price part, the same shall be treated as null and void.	
7.	Confirm that correction fluid is not used in the price part. (In case of any correction, the same shall be signed and stamped by authorized signatory).	
8.	Confirm that you have studied complete Bidding Document including Technical and commercial part and your Bid is in accordance with the requirements of the Bidding Document.	
9.	Confirm your compliance to total Scope of Work mentioned in the Bidding Document.	
10.	Confirm your acceptance for 'Scope of Work' as mentioned in Bidding Document.	
11.	Confirm your compliance to critical stipulations of tender document as mentioned below	
i	Contract Performance Security – clause no. 29.0 of GCC	
ii	Schedule of Rates – clause no. 21.0 of GCC	
iii	Arbitration – clause no. 27.0 of GCC	
iv	Termination – Clause nos. 53.0 & 54 of GCC	
v	Terms of Payment – as per tender document	

 MAHARASHTRA NATURAL GAS LIMITED	<u>Tender for Bi-Annual Rate Contract for procurement of stickers & Nozzle Holder for CNG Dispenser for MNGL, Pune.</u> Bid No.: MNGL/C&P/2018-19/45
---	---

Sl. No.	MNGL's Query	Bidder's Reply/ Confirmation
vii	Price Reduction Schedule as mentioned in bidding document	
12.	Confirm your acceptance for `Time Schedule' as mentioned in Bidding Document.	
13.	Confirm that your quoted price includes following taxes/ duties, insurance etc.	
i)	All taxes, charges and duties assessed or levied in respect of profits earned or income receivable by the Contractor by reason of this Contract.	
ii)	All taxes, duties as per applicable for this WORK in accordance with the provision of General Conditions of Contract and Special Conditions of Contract.	
iii)	All types of insurance as per the provisions of General Conditions of Contract and Special Conditions of Contract.	
14.	Confirm that you have proposed adequate project/ site organization with qualified supervisory personnel having requisite experience	
	Note: Please note that Schedule of Rates/ Prices embodied in the Bidding Document is deemed to include all activities of work specified under Scope of Work, Scope of Supply, technical specifications, Conditions of Contract, drawings or any other document forming part of Bidding Document, irrespective of whether such activities of work are specified in the Schedule of Rates/ Prices or not.	

(STAMP & SIGNATURE OF BIDDER)



**MAHARASHTRA NATURAL
GAS LIMITED**

**Tender for Bi-Annual Rate Contract for procurement of
stickers & Nozzle Holder for CNG Dispenser for MNGL,
Pune.**

Bid No.: MNGL/C&P/2018-19/45

CHECK LIST

{Annexure – III to Instruction to Bidder (ITB)}



**MAHARASHTRA NATURAL
GAS LIMITED**

**Tender for Bi-Annual Rate Contract for procurement of
stickers & Nozzle Holder for CNG Dispenser for MNG L,
Pune.**

Bid No.: MNG L/C&P/2018-19/45

CHECK LIST FOR SUBMISSION OF BID

Bidder is requested to fill this check list and ensure that all details/ documents have been furnished as called for in the Bidding Document along with duly filled in, signed & stamped **check list with each copy of the “Unpriced Part”** of his bid.

(A) EMD/ BG DETAILS ETC.

(A.1) Letter of Submission (i.e. F-2: Bid Form)
Submitted

(A.2) EMD/ BID GUARANTEE/ BID SECURITY

Bidder to confirm that EMD/
Bid Guarantee/ Bid Security has
Been submitted by them as
per Tender Proforma (i.e. F4)
Submitted

(1) By Bank Guarantee
BG No. _____ dt. _____ from
Bank _____ Branch _____
For Rs. _____
Valid Till _____

OR

(2) By Demand Draft
DD No. _____ dt. _____
Drawn on _____
For Rs. _____

Original shall be submitted in original copy and its zerox copy in other copies.

(A.3) CHECK LIST
This check list duly filled in
Submitted

(B) CONFIRMATION OF VARIOUS FORMATS

(B.1) Past Similar work done during
five years as per Format: F-8
Submitted

(B.2) Present Commitments as per Format: F-9
Submitted

(B.3) Financial Details as per Format: F-3A
Submitted



MAHARASHTRA NATURAL GAS LIMITED

Tender for Bi-Annual Rate Contract for procurement of stickers & Nozzle Holder for CNG Dispenser for MNGL, Pune.

Bid No.: MNGL/C&P/2018-19/45

(B.4) Audited Balance Sheet including profit and loss account statement for the last three years

Submitted

Submitted for the years:

- 1) _____
- 2) _____
- 3) _____

(B.5) Goods & Service Tax Registration Certificate

Submitted

GST Registration No. _____

(B.6) Power of Attorney in favour of the person who has signed the bid on stamp paper of appropriate value

Submitted

(B.7) Partnership Deed in case of partnership firm and Article of Association in case of limited company

Submitted

(B.8) A copy of SOR (without prices) duly signed, & stamped as per SOR Format

Submitted

(C) DEVIATION (IF ANY)

(C.1) Deviation (if any) as per Format - F-6 :

Submitted

(C.2) Reply to commercial questionnaire, technical questionnaire with Bidder's reply/ confirmation for each

Submitted

(D) REGARDING TECHNICAL DETAILS

(D.1) Technical Details / Documents specified in Technical Part



**MAHARASHTRA NATURAL
GAS LIMITED**

**Tender for Bi-Annual Rate Contract for procurement of
stickers & Nozzle Holder for CNG Dispenser for MNG L,
Pune.**

Bid No.: MNG L/C&P/2018-19/45

Submitted

Not Applicable

(E) **CONFIRM THE FOLLOWING REGARDING OVERALL BID DOCUMENT**

- | | | | |
|-------|---|------------|--------------------------|
| (E.1) | All pages of the bid have been page numbered in sequential manner | YES | <input type="checkbox"/> |
| (E.2) | The bid has been submitted in requisite number of copies as specified in Instructions to Bidders | YES | <input type="checkbox"/> |
| (E.3) | Original copy of Bidding Document & Drawings along with Addendum, if any, has been submitted along with offer, duly signed and stamped on each page | YES | <input type="checkbox"/> |
| (E.4) | Prices in ONE ORIGINAL only have been submitted in a separately sealed envelope with price part | YES | <input type="checkbox"/> |

(STAMP & SIGNATURE OF BIDDER)



**MAHARASHTRA NATURAL
GAS LIMITED**

**Tender for Bi-Annual Rate Contract for procurement of
stickers & Nozzle Holder for CNG Dispenser for MNGL,
Pune.**

Bid No.: MNGL/C&P/2018-19/45

PART -C

GENERAL CONDITIONS OF CONTRACT (GCC-WORKS)

 MAHARASHTRA NATURAL GAS LIMITED	<u>Tender for Bi-Annual Rate Contract for procurement of stickers & Nozzle Holder for CNG Dispenser for MNGL, Pune.</u> Bid No.: MNGL/C&P/2018-19/45
---	---

GENERAL CONDITIONS OF CONTRACT

1. DEFINITIONS OF TERMS :

In this CONTRACT (as hereinafter defined) the following words and expressions shall have the meaning here by assigned to them except where the context otherwise required.

- 1) The OWNER/COMPANY/PRINCIPAL EMPLOYER/MNGL mean MAHARASHTRA NATURAL GAS LIMITED having its Registered & Corporate office at Plot No. 27, 1st Floor, Narveer Tanajiwadi PM PML Bus Depot Commercial Building, Shivajinagar, Pune - 411005 and includes its successors and assigns.
- 2) The "CONTRACTOR" means the person or the persons, firm or company or Corporation whose tender has been accepted by the OWNER and includes the CONTRACTOR'S legal Representatives his successors and permitted assigns.
- 3) The "Officer-in-charge / Engineer-in-charge" shall mean the person/ persons designated from time to time by the MNGL and shall include those who are expressly authorized by him to act for and on his behalf for operation of this CONTRACT.
- 4) The "WORK" shall means and include all items and things to be supplied/done and services activities to be performed by the CONTRACTOR in pursuant to and in accordance with CONTRACT or part thereof as the case may be and shall include all extra, additional, altered or substituted works as required for purpose of the CONTRACT.
- 5) "CONTRACT DOCUMENTS" means collectively the Tender Documents, Designs, Drawings, Specification, Schedule of Quantities and Rates, Letter of Acceptance and agreed variations if any, and such other documents constituting the tender and acceptance thereof.
- 6) The "SUBCONTRACTOR- means any person or firm or Company (other than the CONTRACTOR) to whom any part of the work has been entrusted by the CONTRACTOR, with the written consent of the Officer-in-charge, and the legal representatives, successors and permitted assigns of such person, firm or company.
- 7) The "CONTRACT" shall mean the Agreement between the OWNER and the CONTRACTOR for the execution of the works including therein all contract documents.
- 8) The "TENDER" means the proposal along with supporting documents submitted by the CONTRACTOR for consideration by the OWNER.
- 9) The "ALTERATION ORDER" means an order given in writing by the Officer-in-charge to effect additions to or deletions from and alteration in the works.



**MAHARASHTRA NATURAL
GAS LIMITED**

**Tender for Bi-Annual Rate Contract for procurement of
stickers & Nozzle Holder for CNG Dispenser for MNGL,
Pune.**

Bid No.: MNGL/C&P/2018-19/45

- 10) The "APPOINTING AUTHORITY" for the purpose of arbitration shall be the MANAGING DIRECTOR or any other person so designated by the OWNER.
 - 11) "NOTICE IN WRITING OR WRITTEN NOTICE" shall mean a notice in written, typed or printed characters sent (unless delivered personally) or otherwise proved to have been received by the addressee by registered post to the latest known private or business address or registered office of the addressee and shall be deemed to have been received in the ordinary course of post it would have been delivered.
 - 12) "APPROVED" shall mean approved in writing including subsequent written confirmation of previous verbal approval and "APPROVAL" means approval in writing including as aforesaid.
 - 13) "FAX/LETTER OF INTENT/SERVICE ORDER" shall mean an intimation by a FAX/Letter to Tenderer(s) that the tender has been accepted in accordance with the provisions contained in the letter.
 - 14) "DAY" means a day of 24 hours from midnight to midnight irrespective of the number of hours worked in that day.
 - 15) "WORKING DAY" means any day which is not declared to be holiday or rest day by the OWNER.
 - 16) "WEEK" means a period of any consecutive seven days.
 - 17) "VALUE OF CONTRACT" shall mean the sum accepted or the sum calculated in accordance with the prices accepted in tender and/or the CONTRACT rates as payable to the CONTRACTOR for the entire execution and full completion of the work.
2. The contractor hereby confirms that he has already inspected the work site has clearly assessed the nature and extent of work and the conditions under which it will be carried out.
 3. Contractor hereby agrees to provide services and necessary supervision to carry out the work set down in the Schedule of works which forms part of this contract in accordance with the conditions of contract laid down in this part of the contract read in conjunction with specific instructions given in part of this contract by utilizing the materials / services if any, agreed to be given by the Company and listed in Annexure . The contractor has to provide necessary services to carry out the work. The work executed shall be to the satisfaction of MNGL, and contract rates shall include for any incidental and contingent work although not specifically mentioned in the contract but is necessary and for its completion in an efficient and workman like manner.
 4. The rates agreed herein shall remain firm till the expiry of the contract and extended period. The contractor shall not be entitled to any increase or revision (except Statutory) or any other right or claim whatsoever by way of representation, explanation or



**MAHARASHTRA NATURAL
GAS LIMITED**

**Tender for Bi-Annual Rate Contract for procurement of
stickers & Nozzle Holder for CNG Dispenser for MNGL,
Pune.**

Bid No.: MNGL/C&P/2018-19/45

- statement or elect to have been given away by any employee representation or any undertaking or promise given or elect to have been given by any employee of the company or due to contractor's own ignorance or on account of any difficulties or hardship faced by him. His rates are all inclusive. However, GST as imposed by State / Central Govt. if applicable, shall be payable by MNGL at actual subject to submission of GST regn. No.
- 5.** All persons deployed by the contractor shall be on his pay roll and should pay wages, PF contribution and Bonus as prescribed by Govt. and the company have no liability whatsoever in this regard. The persons deployed by the contractor shall remain under his control, supervision & discipline. The CONTRACTOR shall have the power to transfer, re - deploy and terminate their services. The CONTRACTOR shall regularly make full payment of wages and salaries not less than the minimum wages, as applicable to the persons engaged by him as required by him under the law.
 - 6.** No part of the contract nor any share of interest therein shall in any manner or degree be transferred / assigned or sublet by the contractor directly or indirectly to any persons, firm or corporation whatsoever.
 - 7.** The Contractor shall be responsible for providing proper services and exercise control over persons deployed by him. He shall also be bound to prohibit and prevent his employee from taking any direct and indirect interest and/or support, assist, maintain, or help from any person or persons engaged in any anti-social activities demonstrations riots or agitation, which may in any way be detrimental or prejudicial to the inter- land / properties in the neighborhood. In the event of any such actions by his persons or persons, contractor shall be fully and exclusively responsible therefore and shall keep the company harmless and indemnified from any consequential claims, actions, suits, proceedings, losses, or damages on any ground whatsoever.
 - 8.** All persons of the contractor entering on work premises shall be properly and neatly dressed and wear badges/ Identity cards while working on premises of the company including work site. The contractor shall provide safety shoes, uniform as desired by MNGL.
 - 9.** In case of the company considers presence of any of the persons of the contractor undesirable for whatever reasons including integrity, conduct, competence, 24 hours notice in writing will be given by company to the contractor on receipt of the said notice, such a person will not be reemployed without express and written authorization of MNGL.
 - 10.** Any failure on part of the COMPANY at any time to enforce the strict observance of the performance of any of the terms and conditions of this CONTRACT or non-exercise of any right mentioned in the contract shall not constitute a waivers of such terms, conditions or rights and shall not affect or deprive the COMPANY to exercise the same at any later date.
 - 11.** CONTRACTOR shall from time to time during the progress of the service issue such further instructions as shall be necessary for the purpose of proper and adequate execution of the services.



**MAHARASHTRA NATURAL
GAS LIMITED**

**Tender for Bi-Annual Rate Contract for procurement of
stickers & Nozzle Holder for CNG Dispenser for MNGL,
Pune.**

Bid No.: MNGL/C&P/2018-19/45

- 12.** The contractor shall remove or replace any workman whom the company considers incompetent or unsuitable.
- 13.** MNGL reserves the right to alter the scope of work in quantum as per the urgency of work. The contractor shall accordingly provide services as may be required by contract coordinator on giving a notice of two days
- 14.** CONTRACTOR shall exclusively be liable for non-compliance of the provisions of any acts, laws rules and regulations having execution, bearing over engagement of workers directly or indirectly for execution of work and the CONTRACTOR hereby undertakes to indemnify Maharashtra Natural Gas Limited against all actions, suits, proceedings, claims, losses, damages etc. which may be arise under Minimum Wages Act, Industrial Dispute Act, Family pension and Deposit Linked Insurance scheme or any other Act or statutes not herein specifically mentioned but having direct or indirect application for the persons engaged by the CONTRACTOR under this CONTRACT.
- 15.** Company shall not be liable for or in respect of any damages or compensation for any injuries or for any occupational diseases to any persons engaged by the CONTRACTOR and the CONTRACTOR shall keep the company indemnified thereof.
- 16.** The contractor shall be liable for making good all damages / losses arising out of theft, breakage, pilferage of any office furniture, equipments, fittings and fixtures whatsoever it may be caused directly or indirectly.
- 17.** The CONTRACTOR/his employees/agents/representatives shall not communicate or use in advertising, publicity, sales releases or in any other medium, photographs, or other reproduction of the work under this CONTRACT or descriptions of the site dimensions, quantity, quality or other information, concerning the work unless prior written permission has been obtained from the OWNER.
- 18. RIGHT OF OWNER TO ACCEPT OR REJECT TENDER:-**
The right to accept the tender will rest with the OWNER. The OWNER, however, does not bind himself to accept the lowest tender, and reserves to itself the authority to reject any or all the tenders received without assigning any reason whatsoever. The whole work may be split up between more than one CONTRACTORS or accept in part (not entirely) if considered expedient. Quoted rates should hold good for such eventualities.

Tenders in which any of the particulars and prescribed information are missing or are incomplete in any respect and/or the prescribed conditions are not fulfilled are liable to be rejected. The Tender containing uncalled for remarks or any additional conditions are liable to be rejected.

Canvassing in connection with tenders is strictly prohibited and tenders submitted by the Tenderers who resort to canvassing will be liable to rejection.

- 19. TENDERER'S RESPONSIBILITY:-**
The intending tenderers shall be deemed to have visited the SITE and familiarized themselves thoroughly with the site conditions before submitting the tender. Non-familiarity with the site conditions will not be considered a reason either for extra

 MAHARASHTRA NATURAL GAS LIMITED	<u>Tender for Bi-Annual Rate Contract for procurement of stickers & Nozzle Holder for CNG Dispenser for MNGL, Pune.</u> Bid No.: MNGL/C&P/2018-19/45
---	---

claims or for not carrying out the works in strict conformity with the DRAWINGS and SPECIFICATIONS.

20. SIGNING OF THE CONTRACT:-

The successful tenderer shall be required to execute an AGREEMENT in the proforma attached with Tender Document within 15 days of the receipt by him of the LETTER OF INTENT OR SERVICE ORDER whichever is earlier.

21. NOTE TO SCHEDULE OF RATES:-

The Schedule of Rates should be read in conjunction with all the other sections of the tender.

The tenderer shall be deemed to have studied the details of WORK to be done within TIME SCHEDULE and to have acquainted himself of the conditions prevailing at site.

Rates must be filled in the schedule of Rates of original Tender Documents. If quoted in separate typed sheets, no variation in item description or specification shall be accepted. Any exceptions taken by the tenderer to the schedule of Rates shall be brought out in the terms and conditions of offer.

The quantities shown against the various items are only approximate. Any increase or decrease in the quantities shall not form the basis of alteration of the rates quoted and accepted.

The OWNER reserves the right to interpolate the rates for such items of work falling between similar items or lower and higher magnitude.

22. POLICY FOR TENDERS UNDER CONSIDERATION:-

Only those Tenders which are complete in all respects and are strictly in accordance with the Terms and conditions and Technical Specifications of Tender Document, shall be considered for evaluation. Such Tenders shall be deemed to be under consideration immediately after opening of Tender and until such time an official intimation of acceptance/rejection of Tender is made by MNGL to the Tenderer.

MNGL if necessary, will obtain clarifications on the Tender by requesting for such information/clarifications from any or all Tenderers either in writing or through personal contact, as may be necessary, and the Tenderers are advised to refrain from contacting by any means MNGL and/or their employee(s)/representative(s) on their own, on matters related to Tenders under consideration. Tenderers will not be permitted to change the substance of the Tenders after opening of Tenders.

23. CONTRACTOR TO INDEMNIFY THE MNGL:

The contractor shall indemnify the MNGL against all actions, proceedings claims, demands, costs and expenses which may be made against the MNGL or government for or in respect of or arising out of any failure by the contractor in the performance of his obligation under the contract document. MNGL shall not be liable for or in respect of any demands or compensation payable under any law in respect of any consequence of any accident or injury to any workmen or other person in the contractor shall indemnify and keep indemnified MNGL against all such damages and compensation & against all claims, demands proceedings, costs, charges and expenses whatsoever in respect thereof or in relation thereto.



**MAHARASHTRA NATURAL
GAS LIMITED**

**Tender for Bi-Annual Rate Contract for procurement of
stickers & Nozzle Holder for CNG Dispenser for MNGL,
Pune.**

Bid No.: MNGL/C&P/2018-19/45

- 24.** Following documents form the part of this contract.
- Instructions to bidders,
 - Bid qualification criteria,
 - General conditions of contract.
 - Special conditions of contract and
 - Schedule of work / rates.

In case of doubt or dispute as to the interpretation of any clause contained, the decision of the company shall be final and binding on the contractor.

25. FORCE MAJURE:

If at any time during the currency of the contract the performance in whole or part by either party, or any obligation under this contract shall be prevented or delayed by reason of any hostility, act of public enemy, civil commotion, sabotage, fire floods, explosions, epidemics, quarantine, strikes, lookouts or acts of God (hereinafter referred to as events) then provided notice of the happening of any such events is given by either party to the other forthwith by not exceeding four hours from time of occurrence thereof, neither party shall by reason of any such event be entitled to have claim for charges / compensation / damages against the other in respect of such non-performance and / or delay in performance during such period.

26. LABOUR LAWS :

- No labour below the age of 18 (eighteen) years shall be employed on the WORK.
- The CONTRACTOR shall not pay less than what is provided under law to labourers engaged by him on the WORK.
- The CONTRACTOR shall at his expense comply with all labour laws and keep the PRINCIPAL EMPLOYER indemnified in respect thereof.
- The CONTRACTOR shall pay equal wages for men and women in accordance with applicable labour laws.
- If the CONTRACTOR is covered under the Contract labour (Regulation and Abolition) Act, he shall obtain a license from licensing authority (i.e. office of the labour commissioner) by payment of necessary prescribed fee and the deposit, if any, before starting the WORK under the CONTRACT. Such fee/deposit shall be borne by the CONTRACTOR.
- The CONTRACTOR shall employ labour in sufficient numbers either to maintain the required rate of progress and of quality to ensure workmanship of the degree specified in the CONTRACT and to the satisfaction of the Officer-in-charge.
- The CONTRACTOR shall furnish to the Officer-in-charge the distribution return of the number and description, by trades of the work people employed on the works. The CONTRACTOR shall also submit on the 4th and 19th of every month to the Officer-in-charge a true statement showing in respect of the second half of the proceeding month

 MAHARASHTRA NATURAL GAS LIMITED	<u>Tender for Bi-Annual Rate Contract for procurement of stickers & Nozzle Holder for CNG Dispenser for MNGL, Pune.</u> Bid No.: MNGL/C&P/2018-19/45
---	---

and the first half of the current month (1) the accidents that occurred during the said fortnight showing the circumstances under which they happened and the extent of damage and injury caused by them and (2) the number of female workers who have been allowed Maternity Benefit as provided in the Maternity Benefit Act 1961 or Rules made there under and the amount paid to them.

- h) The CONTRACTOR shall comply with the provisions of the payment of wages Act 1986, Minimum Wages Act 1948, Employers liability Act 1935, workmen's Compensation Act 1923, Industrial Disputes Act 1947, the Maternity Benefit Act 1961 and Contract Labour Regulation and Abolition Act 1970, Employment of Children Act 1938 or any modifications thereof or any other law relating thereto and rules made there under from time to time.
- i) The Officer-in-charge shall on a report having been made by an Inspecting officer as defined in Contract Labour (Regulation and Abolition) Act 1970 have the power to deduct from the money due to the CONTRACTOR any sum required or estimated to be required for making good the loss suffered by a Worker or Workers by reason of non-fulfillment of the Conditions of the Contract for the benefit of workers, non-payment of wages or of deductions made from his or their wages which are not justified by the terms of the Contract or non-observance of the said regulations.
- j) The CONTRACTOR shall indemnify the OWNER against any payments to be made under and for the observance of the provisions of the aforesaid Acts without prejudice to his right to obtain indemnity from his SUBCONTRACTOR. In the event of the CONTRACTOR committing a default or breach of any of the provisions of the aforesaid Acts as amended from time to time, of furnishing any information or submitting or filling and Form/Register/Slip under the provisions of these Acts which is materially incorrect then on the report of the inspecting Officers, the CONTRACTOR shall without prejudice to any other liability pay to the OWNER a sum not exceeding Rs.50.00 as Liquidated Damages for every default, breach or furnishing, making, submitting, filling materially incorrect statement as may be fixed by the Officer-in-charge and in the event of the CONTRACTOR'S default continuing in this respect, the Liquidated Damages may be enhanced to Rs.50.00 per day for each day of default subject to a maximum of one percent of the estimated cost of the WORKS put to tender. The Officer-in-charge shall deduct such amount from bills or Security Deposit of the CONTRACTOR and credit the same to the Welfare Fund constituted under these acts. The decision of the Officer-in-charge in this respect shall be final and binding.

27. ARBITRATION:

Except where otherwise provided in the tender documents, all questions and disputes or difference relating to or arising under the terms and conditions or as to any other question, claim, right matter or thing, whatsoever in any way arising out of or relating to the terms and conditions of the contract or the execution of failure to execute the same whether arising during the progress of the work after the completion or abandonment thereof shall be referred to the arbitration of sole arbitrator to be appointed by Managing Director, MNGL. There should be no objection from the contractor to any such appointment on the grounds that the Arbitration is an employee of the MNGL and that he

 MAHARASHTRA NATURAL GAS LIMITED	<u>Tender for Bi-Annual Rate Contract for procurement of stickers & Nozzle Holder for CNG Dispenser for MNGL, Pune.</u> Bid No.: MNGL/C&P/2018-19/45
---	---

had to deal with the matter to which the contract relates and that in the course of his duties as an employee of the MNGL he had expressed vices on all or any of the matters in disputes or difference. The arbitrator to whom the matter is originally referred, being unable to act for any reason, Managing Director shall appoint another person to act as some arbitration in accordance with the terms and conditions of the contract. Such persons shall be entitled to proceed with the reference from the stage at which it was left by his predecessor. It is also a term of this contract that no person other than a person appointed by the Managing Director as aforesaid should act as arbitrator and if for any reason that is not possible, the matter is not to be referred to Arbitrator at all.

28. EARNEST MONEY DEPOSIT / BID SECURITY

The tenderer must pay Earnest Money as given in the letter/notice inviting tenders and attach the official receipt with the tender failing which the tender is liable to be rejected and representatives of such tenderers will not be allowed to attend the tender opening, Earnest Money can be paid in Demand Drafts, or Bank Guarantee of any Nationalised / Scheduled Bank in favour of MAHARASHTRA NATURAL GAS LIMITED.

NOTE: The Bank Guarantee so furnished by the tenderer shall be in the proforma prescribed by the OWNER (as per F-4 above). No interest shall be paid by the OWNER on the Earnest Money deposited by the tenderer. The Bank Guarantee furnished in lieu of Earnest Money shall be kept valid for a period of "**two month/60 days beyond the date of validity of the tender**". The EMD shall be forfeited in the event of the bidder withdrawing his offer.

The Earnest Money deposited by successful tenderer will be retained towards the security deposit for the fulfillment of the CONTRACT, but shall be forfeited if the tenderer fails to deposit the requisite Security deposit as per clause 29 of General Terms of contract hereof and /or fails to start work within a period of 15 days or fails to execute the AGREEMENT (As per Appendix - proforma of Agreement) within 10 days of the receipt by him of the Notification of Acceptance of Tender.

The Earnest Money of the unsuccessful tenderers will be refunded by MNGL directly to the tenderers within a reasonable period of time. Correspondence in this regard may be addressed to MNGL directly by the TENDERERS.

Note : The Indian / Domestic firms registered with NSIC / MSME, under its single point registration scheme are exempted from furnishing Earnest Money Deposit / Bid Security, provided they are registered for the items / work they intend to quote and subject to their enclosing with their bid a copy of latest and current registration certificate.

29. Performance Bank Guarantee / Security Deposit: The contractor shall submit Bank Guarantee in our prescribed format, for a value of 10% of annualized Contract value, in favour of MNGL, valid for a period of 27 months as security deposit, from Nationalized/ Scheduled bank except Co-operative bank within 15 days from the date of issue of this service order. The Security Deposit will not bear any interest. Any amount due to MNGL, as per contractual terms & conditions shall be deducted from Security Deposit. In case Security Deposit is not sufficient to recover the outstanding amount, then MNGL reserves the right to recover the same from any other means available to MNGL.

 MAHARASHTRA NATURAL GAS LIMITED	<u>Tender for Bi-Annual Rate Contract for procurement of stickers & Nozzle Holder for CNG Dispenser for MNGL, Pune.</u> Bid No.: MNGL/C&P/2018-19/45
---	---

In case of failure to submit the Security Deposit within the stipulated time, the LOI (Letter of Intent)/ Service Order issued may be withdrawn & EMD submitted against the tender may be forfeited.

30. RIGHT OF THE OWNER TO FORFEIT SECURITY DEPOSIT:

Whenever any claim against the CONTRACTOR for the payment of a sum of money arises out or under the CONTRACT, the OWNER shall be entitled to recover such sum by appropriating in part or whole the security Deposit of the CONTRACTOR. In the event of the security being insufficient or if no security has been taken from the CONTRACTOR, then the balance or the total sum recoverable, as the case may be shall be deducted from any sum then due or which at any time thereafter may become due to the CONTRACTOR. The CONTRACTOR shall pay to the OWNER on demand any balance remaining due.

31. The contractor shall execute an agreement with MNGL within 15 days form the award of contract. However agreement shall be executed only after submission of valid Security Deposit against the contact.

32. Mobilization Period: The deployment for the services shall be within **15 days** or earlier from the date of intimation by Officer-in-charge (OIC) of MNGL, Pune. In case of failure, MNGL reserves the right to cancel the contract.

33. Payment Terms :

As per terms mentioned at Scope of Work.
The bill shall be certified by Officer-in-charge. The bills shall be submitted along with all requisite documents.

34. Contract Period :

The period of contract shall be 2 (two) years from the date service order, further extendable for another 1 (one) year on the same terms & conditions.

35. Insurance:

CONTRACTOR as far as possible shall cover insurance with Indian Insurance companies, including marine Insurance during ocean transportation.

i) EMPLOYEES STATE INSURANCE ACT (ESI):

The CONTRACTOR agrees to and does hereby accept full and exclusive liability for the compliance with all obligations imposed by the Employee State Insurance Act 1948 and the CONTRACTOR further agrees to defend, indemnify and hold OWNER harmless for any liability or penalty which may be imposed by the Central, State or Local authority by reason of any asserted violation by CONTRACTOR or of the Employees' State Insurance Act, 1948, and also from all claims, suits or proceeding that may be brought against the OWNER arising under, growing out of or by reasons of the work provided for by this CONTRACTOR whether brought by employees of the CONTRACTOR, by third parties or by Central or State Government authority or any political subdivision thereof.



**MAHARASHTRA NATURAL
GAS LIMITED**

**Tender for Bi-Annual Rate Contract for procurement of
stickers & Nozzle Holder for CNG Dispenser for MNGL,
Pune.**

Bid No.: MNGL/C&P/2018-19/45

The CONTRACTOR agrees to fill in with the Employee's State Insurance Corporation, the Declaration Forms, and all forms which may be required in respect of the CONTRACTOR'S or subcontractor's employees, who are employed in the WORK provided for or those covered by ESI from time to time under the Agreement. The CONTRACTOR shall deduct and secure the agreement of the to deduct the employee's contribution as per the first schedule of the Employee's State Insurance Act from wages and affix the Employees Contribution Card at wages payment intervals. The CONTRACTOR shall remit and secure the agreement of to remit to the State Bank of India. Employee's State Insurance Corporation Account, the Employee's contribution as required by the Act. The CONTRACTOR agrees to maintain all Cards and Records as required under the Act in respect of employees and payments and the CONTRACTOR shall secure the agreement of the to maintain such records. Any expenses incurred for the contribution, making contributions or maintaining records shall be to the CONTRACTOR'S account.

The OWNER shall retain such sum as may be necessary from the total VALUE OF CONTRACT will the CONTRACTOR shall furnish satisfactory proof that all contributions as required by the Employees State Insurance Act,1948, have been paid. This will be pending on the CONTRACTOR when the ESI Act is extended to the place of work.

ii) EMPLOYEE'S COMPENSATION AND EMPLOYER'S LIABILITY INSURANCE:

Insurance shall be effected for all the CONTRACTOR'S employees engaged in the performance of this CONTRACT. If any of the work is sublet, the CONTRACTOR shall require to provide workman's Compensation and employer's liability insurance for the later's employees if such employees are not covered under the CONTRACTOR'S Insurance.

iii) ANY OTHER INSURANCE REQUIRED UNDER LAW OR REGULATIONS OR BY OWNER :

CONTRACTOR shall also carry and maintain any and all other insurance(s) which he may be required under any law or regulation from time to time without any extra cost to OWNER. He shall also carry and maintain any other insurance which may be required by the OWNER.

iv) ACCIDENT OR INJURY TO WORKMEN:

The OWNER shall not be liable for or in respect of any damages or compensation payable at law in respect or in consequence of any accident or injury to any workman or other person in the Employment of the CONTRACTOR or any save and except an accident or injury resulting from any act or default of the OWNER, his agents or servants and the CONTRACTOR shall indemnify and keep indemnified the OWNER against all such damages and compensation (save and except and aforesaid) and against all claims, demands, proceeding, costs, charges and expenses, whatsoever in respect or in relation thereto.

36. DAMAGE TO PROPERTY OR TO ANY PERSON OR ANY THIRD PARTY :



**MAHARASHTRA NATURAL
GAS LIMITED**

**Tender for Bi-Annual Rate Contract for procurement of
stickers & Nozzle Holder for CNG Dispenser for MNGL,
Pune.**

Bid No.: MNGL/C&P/2018-19/45

- i) CONTRACTOR shall be responsible for making good to the satisfaction of the OWNER any loss or any damage to structures and properties belonging to the OWNER or being executed or procured or being procured by the OWNER or of other agencies with in the premises of all the work of the OWNER, if such loss or damage is due to fault and/or the negligence or willful acts or omission of the CONTRACTOR, his employees, agents, representatives etc.
- ii) The CONTRACTOR shall take sufficient care that employees /representatives/agents do not cause any damage to any person or to the property of the OWNER or any third party and in the event of any damage resulting to the property of the OWNER or of a third party cost of such damages including eventual loss of production, operation or services in any plant or establishment as estimated by the OWNER or ascertained or demanded by the third party shall be borne by the CONTRACTOR.
- iii) The CONTRACTOR shall indemnify and keep the OWNER harmless of all claims for damage to property other than OWNER'S property arising under or by reason of this agreement, if such claims result from the fault and/or negligence or willful acts or omission of the CONTRACTOR, his employees, agents, subcontractors, his agents, representative of subcontractors.

CONTRACTOR shall exclusively be liable for group insurance as per the provision of workman compensation act for the persons engaged/employed by him. Company shall not be liable for or in respect of any damages or compensation to any persons engaged by the CONTRACTOR and the CONTRACTOR shall keep the company indemnified thereof.

37. In case the contractor fails to provide the required services under the contract to the satisfaction of MNGL, MNGL reserves the right to get the services through alternate agencies at the risk and cost of contractor and penal deduction shall be made, from the contractor's bills and the decision of MNGL in this connection shall be final and binding on the contractor.
38. The tenderer hereby agrees to provide services and necessary such provision to carry out the work as given in the scope and description of work.
39. The work executed shall be to the satisfaction of MNGL and contract rules shall include for any incidental and contingent work although not specifically mentioned in the contract but is necessary for the completion in an efficient and workman like manner.
40. The contractor (which shall include the contracting firm / company) shall be solely liable to obtain and abide by all necessary license / permissions from the concerned authorities as provided under the various labour laws / legislation including labour license from the competent authority under The Contract Labour (Regulation & Abolition) Act 1970.
41. The tenderer should have his PF account no. with Regional Provident Fund Commissioner and shall submit to the COMPANY proof of depositing the employee's contribution, on monthly basis.



**MAHARASHTRA NATURAL
GAS LIMITED**

**Tender for Bi-Annual Rate Contract for procurement of
stickers & Nozzle Holder for CNG Dispenser for MNGL,
Pune.**

Bid No.: MNGL/C&P/2018-19/45

- 42.** The contractor shall also be bound to discharge obligations as provided under various statutory enactment including the Employees Provident Fund & Miscellaneous Act, 1952, The Employees State Insurance Act 1948, The Contract Labour (Regulation and Abolition) Act 1970, The Minimum Wages Act 1948, The Payment of Wages Act 1936, Employee's Compensation Act, 1923 and other relevant Acts rules and regulations in force from time to time in respect of the person deployed by him to carry out the obligation under the contract.
- 43.** The contractor shall be responsible for necessary contributions towards PF, ESI or any other statutory payment to Government Agencies as applicable under the law in respect of the contract and of personnel employed by the contractor for rendering services to MNGL and shall deposit the required amounts with the concerned statutory authorities on or before due dates. Each contractor shall obtain a separate P.F. number from the concerned Regional Provident Fund Commissioner and submit necessary proof of having deposited the employees PF and shall be responsible for payment of any administration / inspection charges thereof, wherever applicable, in respect of the personnel deployed by him relating to the work of MNGL.
- 44.** The contractor shall regularly submit all relevant records / documents in this regard to MNGL representative for verification and upon such satisfaction only, MNGL will allow payment to the Contractor.
- 45.** The contractor shall ensure and will be solely responsible for payment of wages and other dues latest by 7th of the following month to the personnel deployed by him. The contractor shall be directly responsible and indemnify the company against all charges, claims, dues and employment of personnel deployed by him.
- 46.** The contractor shall indemnify the company against all losses or damages caused to it on account of acts of the personnel deployed by the contractor.
- 47.** The tenderer shall not engage any person(s) less than eighteen years of age and shall not pay less than what is prescribed under law.
- 48. MNGL RESERVES THE RIGHT TO:**
- i. Reduce the rates at which payment shall be made if the quantity and quality of services although acceptable is not up to required standard.
 - ii. Issue the CONTRACTOR from time to time during the progress of the service such further instructions as shall be necessary for the purpose of proper and adequate execution of the service and the CONTRACTOR shall carry out and be bound by the same.
 - iii. In order the contractor to remove or replace any person engaged in providing the services to the COMPANY whom the company considers incompetent or unsuitable. Opinion of the representative in the competence of any person engaged by the contractor shall be final and binding on the contractor.
- 49. AWARD OF CONTRACT:-**



**MAHARASHTRA NATURAL
GAS LIMITED**

**Tender for Bi-Annual Rate Contract for procurement of
stickers & Nozzle Holder for CNG Dispenser for MNGL,
Pune.**

Bid No.: MNGL/C&P/2018-19/45

The Acceptance of Tender will be intimated to the successful Tenderer by MNGL either by Telegram/Fax or by Letter or like means -defined as LETTER OF INTENT OR SERVICE ORDER.

MNGL will be the sole judge in the matter of award of CONTRACT and the decision of MNGL shall be final and binding.

- 50.** The contractor shall be required to obtain requisite labour license / permission from the appropriate authorities as provided under the various labour regulations, before undertaking any contract work. The contractor shall exclusively be liable for compliance of the provisions of any Act, laws, rules and regulations having execution, taking over engagement of his personnel directly or indirectly for execution of work and the contractor hereby undertakes to indemnify the company against all actions, suits, proceedings, claims, losses, damages etc. which may arise due to his noncompliance of the provisions under various laws mentioned in this document or not herein specifically mentioned but having direct or indirect application for the persons engaged under the contract.
Company shall not be liable in respect of any damages or compensation for any injury or for any occupational diseases, to the employment to any person engaged by the contractor and the contractor shall keep the company indemnified thereof.
- 51.** During the currency of the job, if the work progress does not commensurate with time elapsed in respect of any person / persons engaged, the contractor shall be liable to pay the company compensation as may be considered reasonable by the company.
- 52.** In case of any default for more than three days in respect of services to be provided in accordance with the requirements specified by the officer in charge, Company will have the right to avail the services from other sources at the risk and cost of the contractor or terminate the contract and forfeit his security deposit etc.
- 53.** The company for any reason whatsoever of which the company shall be the sole judge may terminate this contract by giving notice of 30 days and the contractor shall vacate the work place with his men and material on the expiry of such notice period in the event of such termination of the contract. The contractor shall be paid for all the work executed up to the date of terminations of the contract including refund of security deposit subject to deduction of any dues, penalties, other recoveries etc. within a period of two months at the discretion of the officer in charge.
- 54.** MNGL reserve right to short close/ Terminate the contract any time based on non-performance/ poor performance during contractual period by giving 30 days notice.
- 55.** The contractor shall be liable for making good all damages / losses arising out of theft, pilferage of any furniture, equipment, fittings, fixtures, utensils, appliances whatsoever as may be caused directly or indirectly by the persons engaged by the contractor. At the appointed date, place hour the contractor shall make available persons to be engaged along with appropriate tools wherever stated.
- 56.** The contractor shall take charge of all the materials handed over to him by the company and will be responsible for any loss/damage thereof.
- 57.** The contractor shall issue an identity card to all its employees engaged for the services to be provided. The contractor shall also provide at his own cost safety equipments,



**MAHARASHTRA NATURAL
GAS LIMITED**

**Tender for Bi-Annual Rate Contract for procurement of
stickers & Nozzle Holder for CNG Dispenser for MNGL,
Pune.**

Bid No.: MNGL/C&P/2018-19/45

- materials, uniforms etc. to his employees. All the safety rules and regulations will be observed by the persons engaged under this contract.
- 58.** The contract shall be directly and exclusively responsible for any liability arising due to any dispute between him and his employees and shall indemnify the company against all charges, dues, claims etc. arising out of the disputes relating to the dues and employments of personnel deployed by him.
- 59.** The contractor shall ensure regular and effective supervision and control of the personnel deployed by him and give suitable direction for undertaking the contractual obligation.
- 60.** For non-fulfillment of any obligation under the contract, the company reserves the right to withhold the payments due to the contractor and out of such amount or the amounts likely to fall due to the contractor (but without obligation to do so) make such payments as it may consider necessary for smooth working.
- 61.** Contractor shall deploy the resources as per requirements.
- 62.** The company shall have the power to issue necessary instructions to the contractor concerning discipline, decorum, work performance, safety etc. in respect of the employees of the contractor engaged by him for providing the services to the company and the contractor shall ensure compliance of all such instruction strictly.
- 63.** No payments shall be payable other than schedules payment to the contractor.
- 64.** The monthly quoted rates shall be inclusive of Leave wages & other statutory payments for providing such services.
- 65.** Income tax as per rule, any other taxes shall be deducted from contractor's monthly bill / bills. Income Tax deduction certificate shall be issued to the contractors.
- 66.** The bidder shall deemed to have quoted after having satisfied himself to the total nature of work, site of work, surrounding the means access transport availability of services & to have obtained his information on all matters which can in any way influence his offer.
- 67. Jurisdiction:**
The CONTRACT shall be governed by and constructed according to the laws in force in INDIA. The CONTRACTOR hereby submits to the jurisdiction of the Courts situated at PUNE for the purposes of disputes, actions and proceedings arising out the CONTRACT, the courts at PUNE only will have the jurisdiction to hear and decide such disputes, actions and proceedings.
- 68.** Bidder to confirm the unconditional acceptance to the following clauses of the tender
- i) Security Deposit /Performance bank guarantee
 - ii) Schedule of Rates.
 - iii) Termination.
 - iv) Scope of Work.
 - v) Arbitration.
 - vi) Period of Validity Offer.
- 69. DOCUMENTS:**
- 69.1 GENERAL**
The tenders as submitted will consist of the following:



**MAHARASHTRA NATURAL
GAS LIMITED**

**Tender for Bi-Annual Rate Contract for procurement of
stickers & Nozzle Holder for CNG Dispenser for MNGL,
Pune.**

Bid No.: MNGL/C&P/2018-19/45

- i)** Complete set of Tender Documents (Original) duly filled in and signed by the tenderer as prescribed in different clause of the Tender Documents.
- ii)** Earnest money in the manner specified in Clause 28 hereof.
- iii)** Power of Attorney or a true copy thereof duly attested by an officer in case an authorized representative has signed the tender, as required
- iv)** Information regarding Tenderers in the proforma enclosed.
- v)** Details of work of similar type and magnitude carried out by the Tenderer.
- vi)** Latest Balance sheet and profit & Loss Account / Turnover Certificate duly audited.
- vii)** The bidder shall submit the documentary evidence like certificate of registration with PF, ESIC authorities.



**MAHARASHTRA NATURAL
GAS LIMITED**

**Tender for Bi-Annual Rate Contract for procurement of
stickers & Nozzle Holder for CNG Dispenser for MNGL,
Pune.**

Bid No.: MNGL/C&P/2018-19/45

PART - D

SCOPE OF WORK & SPECIAL CONDITIONS OF CONTRACT

 <p>MAHARASHTRA NATURAL GAS LIMITED</p>	<p><u>Tender for Bi-Annual Rate Contract for procurement of stickers & Nozzle Holder for CNG Dispenser for MNGL, Pune.</u></p> <p>Bid No.: MNGL/C&P/2018-19/45</p>
---	--

SCOPE OF WORK & SPECIAL CONDITIONS OF CONTRACT

1.0 Scope of the Work :

Scope for procurement of Stickers, Nozzle Holder and services of Polishing Buffing & Denting etc. for upkeepment & beautification of CNG dispensers.

1. The detail scope of supply shall be as per SOR.
2. Printing & Supply of self-adhesive eco solvent vinyl sticker with good quality of adhesive & PVC sheet (size mentioned in SOR)
3. Colour printing to be done on vinyl stickers as mentioned enclosed specimen with eco solvent colour.
4. The vinyl sticker should be on 120 GSM PVC sheet with 1800 dpi printing.
5. Supply will ensure the material for nozzle holder is SS-316.
6. The entire vinyl sticker should have good quality silicon sheet at back.
7. Supplier will require to get the sticker specimen checked by MNGL official before printing the entire stickers & after approval the printing & supply to be done.
8. Packing and transportation of material to MNGL's premises will be included in the contractor's scope.
9. Required materials including any hardware and tools & tackles like nut & bolt and grinding & drilling machine for complete the pesting of stickers, polishing, buffing & cleaning of dispenses and any fitment activity etc. are in contractor scope.
10. Required Electricity supply/ DG Set to carry out above said activity tare in Contractor Scope.
11. Supplier will be make self-arrangement (like accommodation and transportation facility) during actual work throughout 2 years ARC and is in contractor scope.
12. MNGL will designate Engineer In Charge to look after the work on its sole discretion.
13. Delivery/Completion Schedule – Within 1 weeks after intimation given by EIC.
14. Payment shall be made on the basis of actual work done and as per MNGL standard procedure.
15. It also includes designing, translation of language, supply, installation, etc.



**MAHARASHTRA NATURAL
GAS LIMITED**

**Tender for Bi-Annual Rate Contract for procurement of
stickers & Nozzle Holder for CNG Dispenser for MNGL,
Pune.**

Bid No.: MNGL/C&P/2018-19/45

16. Hose Holder - Drawing

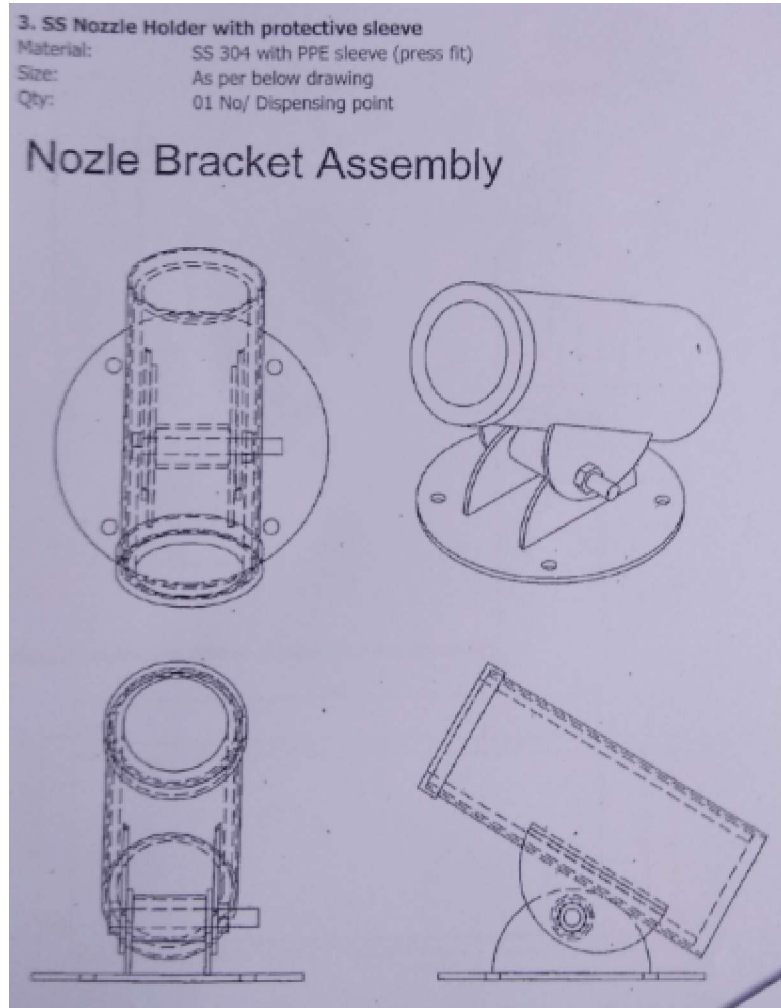

2.0 **Contract Period:**

The period of contract shall be 2 (two) years from the date service order, further extendable for another 1 (one) year on the same terms & conditions.

3.0 **Payment Terms**

The terms of payment shall be as follows:

- Payment shall be made within 10 days after completion of the individual activity & submission of invoice & necessary documents certified by Engineer In Charge (EIC), on pro rata basis.



**MAHARASHTRA NATURAL
GAS LIMITED**

**Tender for Bi-Annual Rate Contract for procurement of
stickers & Nozzle Holder for CNG Dispenser for MNGL,
Pune.**

Bid No.: MNGL/C&P/2018-19/45

- Paying Authority (Indigenous/ Imported):
Director (Commercial)
Maharashtra Natural Gas Ltd.
Plot no. 27, Narvir Tanaji Wadi,
PMPML Bus Depot, Commercial Building,
1st Floor, Shivajinagar
Pune – 411005

5.0 PRICE REDUCTION SCHEDULE :

Time is the essence of the CONTRACT. In case the CONTRACTOR fails to complete the WORK within the stipulated period, then, unless such failure is due to Force Majeure as defined in contract here above or due to EMPLOYER's defaults, the total value of each assignment placed by EIC shall be reduced by ½% of the total value of each assignment placed by EIC per complete week of delay or part thereof subject to a maximum of 5% of the each assignment value, by way of reduction in price for delay and not as penalty. The said amount will be recovered from amount due to the Contractor/ Contractor's Contract Performance Security payable on demand.

The decision of the ENGINEER-IN-CHARGE in regard to applicability of Price Reduction Schedule shall be final and binding on the CONTRACTOR.

All sums payable under this clause is the reduction in price due to delay in completion period at the above agreed rate.



**MAHARASHTRA NATURAL
GAS LIMITED**

**Tender for Bi-Annual Rate Contract for procurement of
stickers & Nozzle Holder for CNG Dispenser for MNGL,
Pune.**

Bid No.: MNGL/C&P/2018-19/45

PART E

SCHEDULE OF RATES (SOR)

 MAHARASHTRA NATURAL GAS LIMITED	<u>Tender for Bi-Annual Rate Contract for procurement of stickers & Nozzle Holder for CNG Dispenser for MNGL, Pune.</u> Bid No.: MNGL/C&P/2018-19/45
---	---

SCHEDULE OF RATES (SOR)

Bid document no. MNGL/C&P/2018-19/45 dated 21.07.2018

Sr. No.	ITEM Description	UOM	QUANTITY	Per Unit FOT Site Rate in Rs.	Per Unit Goods & Service Tax in Rs.	Total Amount in Rs.
1	2	3	4	5	6	7 = (5+6) x 4
1	Vinyl sticker with self-adhesive and eco solvent print with fitting and pasting on respective station for ICL make dispenser. Size 2.3X3 Feet	NO	150			
2	Vinyl sticker with self-adhesive and eco solvent print with fitting and pasting on respective station for TG make dispenser. Size 2.6X2.8 Feet	NO	90			
3	Vinyl sticker with self-adhesive and eco solvent print with fitting and pasting on respective station for Parker (Old) make dispenser. Size 2.3 X2.8 feet.	NO	60			
4	Vinyl sticker with self-adhesive and eco solvent print with fitting and pasting on respective station for Parker (New) make dispenser. Size 2.3 X 3 feet.	NO	105			
5	Vinyl sticker with self-adhesive and eco solvent print with fitting and pasting on respective station for COMPAC make dispenser. Size 1.95 X 2.6 feet.	NO	150			
6	Dispenser Polishing Buffing & Denting	NO	225			
7	Hose Holder	NO	400			
TOTAL Amount in Rs.						



**MAHARASHTRA NATURAL
GAS LIMITED**

**Tender for Bi-Annual Rate Contract for procurement of
stickers & Nozzle Holder for CNG Dispenser for MNGL,
Pune.**

Bid No.: MNGL/C&P/2018-19/45

NOTES:

- 1.0 **Evaluation shall be done on overall basis least cost to the MNGL.**
- 2.0 **Bidder shall quote for all the SOR items else bid shall be liable for rejection.**
- 3.0 Unit Rate shall be inclusive of all charges like transportation, insurance, Loading, unloading, etc
- 3.0 The rates should be quoted both in figures and words against each item. In case of any discrepancy between the figures and words, the rate quoted in words will be taken as authentic and final. **PLEASE DO NOT OVERWRITE.** Cut out any errors and write afresh and countersign every such correction. Bids in which, the rates are overwritten or corrections are not countersigned, are liable to be rejected.
- 4.0 **Taxes & Duties if any shall be indicated clearly in your quotation and total amount should be inclusive of all taxes etc.**
- 5.0 **Bidder shall indicate the following rates considered in the prices indicated in the Price Schedule above. Bidder shall note that any error in estimating these taxes & Duties will be to Bidder's Account.**
 - a. **Goods & Service Tax @-----**
Please indicate the break up of above GST as under:
CGST @ _____
SGST @ _____
IGST @ _____
UGST @ _____

Date :

Place :

Signature & Seal of Bidder